

BRITISH CATALOGUE 2009/2010

**STAINLESS STEEL SINKS/PYRAGRANITE SINKS
KITCHEN TAPS**





PYRAMIS COMPANY PROFILE	02
MINIMUM BASE UNIT CLASSIFICATION OF SINKS	08
ANALYSIS OF STAINLESS STEEL SINKS CHARACTERISTICS	12

STAINLESS STEEL SINKS

ELEGANT CATEGORY	
STUDIO	14
CRYSTALON	19
ASTRIS	23
TETRAGON	27

PREMIUM CATEGORY	
DIONE	33
DIMITRA	38
ARIADNE	40
TITAN	42
AMALTIA	43
AMALTIA PLUS	46

CLASSIC CATEGORY	
SPACE	48
SR	50
IRIS	52

ESSENTIAL CATEGORY	
SPARTA	55
BASIC 33	58
BRITISH INSET	60
INSET BOWLS	63

TOP ESSENTIAL CATEGORY	
BRITISH ONSET	66
MODULE	68

ACCESSORIES	70
VALVES - SIPHONS	72
INSTALLATION KIT OF STAINLESS STEEL SINKS	75

PYRAGRANITE SINKS	76
TETRAGON SERIES	78
TETRAGON UNDERMOUNT SERIES	80
AVANT SERIES	82
PETRA SERIES	85

KITCHEN TAPS	88
ELEGANT/PREMIUM	90
CLASSIC/ESSENTIAL	92

PYRAMIS

Introduction to PYRAMIS GROUP



PYRAMIS is one of the leading stainless sink manufacturers in the world with a growing multinational network.

Having created a solid technological infrastructure using years of industry expertise, the company has developed significant international market presence. This has enabled PYRAMIS to establish an efficient sales network in more than 50 countries, including the UK.

The PYRAMIS corporate family



PYRAMIS
Metallurgia A.E.
Greece



PYRAMIS
Polska
Sp. zo. o.



PYRAMIS
Deutschland
GmbH



PYRAMIS
U.K.
Ltd.



PYRAMIS
Romania
S.R.L.



PYRAMIS
Italia
S.R.L.



OOO PYRAMIS
Rus



PYRAMIS
Bulgaria
Ltd.



PYRAMIS
U.A.E



PYRAMIS
Marketing India
PVT. LTD

Our heritage

Years of experience, vision and expertise have raised the profile of PYRAMIS in all markets. Its leading position is the result of the company's commitment to satisfy the differing needs of its domestic and non-domestic customers.

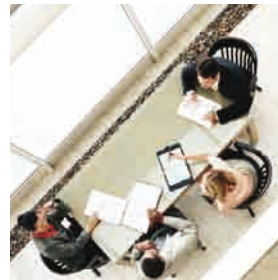
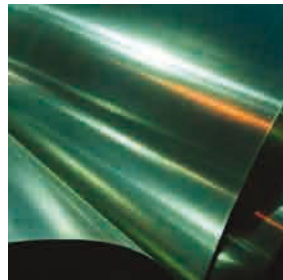
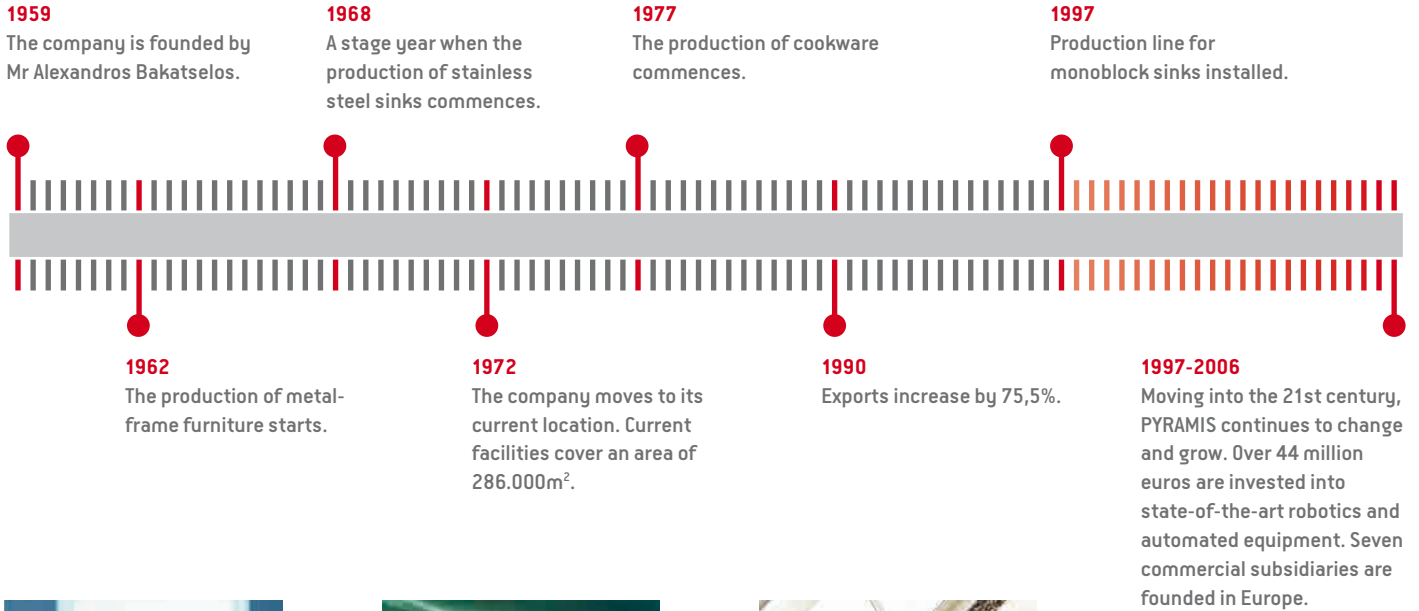

New corporate identity



After nearly 50 successful years in business, 40 of which in the worldwide stainless sink industry, the company has created a new corporate identity to reflect its global expansion.

The new corporate identity reflects the symbol of a pyramid. 'Using a broad base to increase rapidly and progressively – step by step'.

The new PYRAMIS was designed to be visually attractive and to reflect the company's corporate objectives and core values. The strapline was devised to represent the company's intention to offer integrated kitchen solutions for all our customers. 'Kitchen Inspirations' determines our sector of activity in the market while simultaneously indicating a modern, ambitious and design orientated company.

Mission-Vision-Values

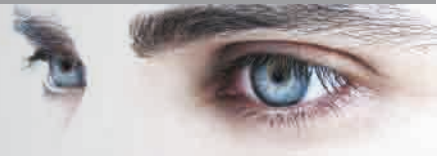

▶ Our mission is to develop and offer complete solutions for the kitchen (and bathroom) that are characterised by high quality functional design. We intend to offer an added value service from a business which is always represented by a human face.

Our vision is to become a powerful, competitive and internationally recognisable group of companies that offers a complete range of products and services, while responding speedily and effectively to the challenges presented by a dynamic environment.

▶ *Honesty*

▶ *Integrity*

▶ *Reliability*

▶ *Teamwork*

▶ *Commitment to the fulfilment of corporate goals and priorities*

▶ *Responsibility*

▶ *Professionalism - Effectiveness*

▶ *Acknowledgment and Rewarding of individual and group effort*

▶ *Extending our Knowledge base*

▶ *Self-awareness and Self-evaluation*

▶ *Passion for our work*

Quality



PYRAMIS is dedicated to providing the utmost quality and excellence in all its products and services, and this forms the foundation of the company's strategies and activities. These essential factors are what give the company its competitive edge, and every PYRAMIS product features CE certification.



PYRAMIS is ISO 9001:2000 certified, ensuring high standards of quality for its products.



PYRAMIS is dedicated to the protection of the environment and possesses the EMAS and ISO 14001 environmental certificates. The EMAS certification is voluntary, and highlights the company's commitment to ecological preservation.



PYRAMIS possesses the OHSAS 18001 human resources certificate.

Web site



▶ At PYRAMIS, we believe that effective communication is a two-way process. In order to understand the needs and desires of our partners and customers, we have developed a user-friendly website for each of our

subsidiaries. We continually work to update the site as we aim to offer a powerful tool that is quick and efficient for all purposes.



▶ Home page
The home page is designed as the starting point to easily reach any available information about the company and individual product categories.

▶ Subsidiary site selector
The entry page is designed to provide direct access to all individual websites of our subsidiaries. At the same time a small company profile for PYRAMIS Group is presented.



▶ Product Family
The product family page provides important information about the selected product category allowing the user to study the unique selling point of any available model.



▶ Product series selector
Provides all the available product series according to the selected product category. This page is the gateway of the analytical presentation of any selected model that will follow at the product data sheet.



























▶ Product data sheet
This is an analytical presentation of the selected product code. It contains a product image, a linear drawing, important technical specifications, the optional accessories and generally all the essential information that any user needs.































STAINLESS STEEL SINKS / PYRAGRANITE SINKS / KITCHEN TAPS























MIN BASE UNIT CLASSIFICATION

30 CM	40 CM	45 CM	45 CM
			
ASTRIS (17X40) 1B	ASTRIS (34X40) 1B	ASTRIS (40X40) 1B	IRIS (40X40) 1B
PAGE 24	PAGE 24	PAGE 25	PAGE 54
			
TETRAGON (17X40) 1B	TETRAGON (34X40) 1B	TETRAGON (40X40) 1B	SPARTA (62X50) 1B 1D
PAGE 28	PAGE 28	PAGE 29	PAGE 55
			
IRIS (16,5X29) 1B	IRIS (34X40) 1B	ARIADNE (79X50) 1B 1D	SPARTA (86X50) 1B 1D
PAGE 53	PAGE 53	PAGE 40	PAGE 56
			
	E 33	ARIADNE (86X50) 1B 1D	BS INSET (50X51) 1B
	PAGE 58	PAGE 41	PAGE 60
			
	ROYAL MINI	AMALTIA (86X50) 1B 1D	BS INSET (131X51) 1B 2D
	PAGE 65	PAGE 44	PAGE 62
			
	PYRAGRANITE	SR MINI	KIBA
	PAGE 78	PAGE 50	PAGE 63
			
		SR 1	KIBA SQUARE
		PAGE 51	PAGE 64
			
		IRIS (Ø38,5) 1B	CR
		PAGE 53	PAGE 64

MIN BASE UNIT CLASSIFICATION

45 CM	50 CM	60 CM	60 CM
			
CT PAGE 65	CRYSTALON (86X53) 1B 1D PAGE 22	STUDIO (100X50) 1 1/2B 1D PAGE 16	DIMITRA RIGHT HAND DRAINER PAGE 39
			
ROYAL PAGE 65	ASTRIS (45X40) 1B PAGE 25	STUDIO (86X50) 1B 1D PAGE 17	ARIADNE (100X50) 1 1/2B 1D PAGE 41
			
PETRA (79X50) 1B 1D PAGE 85	TETRAGON (45X40) 1B PAGE 29	CRYSTALON (100X52) 1 1/2B 1D PAGE 21	AMALTIA (62X50) 1 1/2B PAGE 43
			
PETRA (86X50) 1B 1D PAGE 86	CA 1 PAGE 59	ASTRIS (50X40) 1B PAGE 26	AMALTIA (100X50) 1 1/2B 1D PAGE 45
			
	BS INSET (94X49) 1B 1D REV PAGE 61	TETRAGON (50X40) 1B PAGE 30	AMALTIA PLUS 1B 1D PAGE 46
			
	BS INSET (94X49) 1B 1D PAGE 61	TETRAGON (55X40) 1D PAGE 30	SPACE MINI 1 1/2B 1D PAGE 48
			
	PYRAGRANITE AVANT (86X50) 1B 1D PAGE 82	TETRAGON (57,5X44) 2B PAGE 31	SPACE PLUS 1B PAGE 49
			
		DIONE (59X46) 1 1/2B PAGE 34	SPACE PLUS 1B 1D PAGE 49

MIN BASE UNIT CLASSIFICATION

60 CM	60 CM	80 CM	80 CM
 <p>IRIS (50X40) 1B</p> <p>PAGE 54</p>	 <p>PETRA CORNER (100X50) 1 1/2B 1D</p> <p>PAGE 87</p>	 <p>STUDIO (116X50) 2B 1D</p> <p>PAGE 15</p>	 <p>SPARTA (116X50) 2B 1D</p> <p>PAGE 57</p>
 <p>SPARTA (62X50) 1 1/2B</p> <p>PAGE 56</p>		 <p>CRYSTALON (116X52) 2B 1D</p> <p>PAGE 20</p>	 <p>E 33/33</p> <p>PAGE 59</p>
 <p>SPARTA (100X50) 1 1/2B 1D</p> <p>PAGE 57</p>		 <p>ASTRIS (74X40) 1B</p> <p>PAGE 26</p>	 <p>PYRAGRANITE</p> <p>PAGE 79</p>
 <p>ATRIA</p> <p>PAGE 64</p>		 <p>TETRAGON (74,5X44) 2B</p> <p>PAGE 32</p>	 <p>PYRAGRANITE</p> <p>PAGE 84</p>
 <p>PYRAGRANITE</p> <p>PAGE 79</p>		 <p>DIONE (77X46) 2B</p> <p>PAGE 33</p>	 <p>PETRA (79X50) 2B</p> <p>PAGE 86</p>
 <p>PYRAGRANITE</p> <p>PAGE 83</p>		 <p>DIONE (65X40) 1 1/2B</p> <p>PAGE 35</p>	 <p>PETRA (116X50) 2B 1D</p> <p>PAGE 87</p>
 <p>PYRAGRANITE</p> <p>PAGE 84</p>		 <p>TITAN 1B</p> <p>PAGE 42</p>	
 <p>PETRA (100X50) 1 1/2B 1D</p> <p>PAGE 87</p>		 <p>AMALTIA (116X50) 2B 1D</p> <p>PAGE 45</p>	

90 CM

90 CM



PAGE

STUDIO (86X50) 2B

18



PAGE

PETRA (86X50) 2B

90



PAGE

TETRAGON (86,5X44) 2B

32



PAGE

DIONE (84X46) 2B

36



PAGE

DIONE (85X46) 2B

37



PAGE

AMALTIA (86X50) 2B

44



PAGE

AMALTIA PLUS 2B 1D

47



PAGE

BS INSET (131X51) 2B 1D RH

62



PAGE

PYRAGRANITE
AVANT (86X50) 2B

83

ANALYSIS OF STAINLESS STEEL SINKS CHARACTERISTICS

▶ PRODUCT CODE

Each nine-digit product code represents a particular sink with its own unique specifications.

CODE	FINISH	WASTE	PACKAGING
100090601	BRUSHED STEEL	Ø92	CARTON BOX

▶ STAINLESS STEEL FINISH

There are a variety of stainless steel finishes. The PYRAMIS stainless sinks range incorporates a choice of smooth, linen and microlinen finishes. Brushed stainless steel is a new finish that is exclusive to our Tetragon models.



▶ BOWL POSITION - TAP HOLE(S)

The left or right hand position of the bowl in an installed sink defines the sink as left hand or right hand. In the case of two bowl sinks with one large and one smaller bowl, the position of the larger bowl defines the sink as a left or right hand.

▶ 1+1 TAP HOLES

When the model has 1+1 tap holes, this means that it can also be installed in reverse, and can be either a left or right hand bowl according to a customer's need. In this case, the tap hole that is located at the back of the sink, is for the tap installation, whereas the second tap hole at the front can be covered with a tap hole stopper, or can be used for the installation of an automatic valve. (Pop-up waste)



▶ 1 TAP HOLE

Indicates that a sink is offered with one tap hole for the placement of the tap, and the position of the bowl is either right or left hand side.



▶ In cases where a sink is offered with 2 tap holes, usually one next to the other, this means the sink is not reversible. One aperture is for the tap and the other will normally be used for a soap dispenser or an automatic valve (pop-up waste).



▶ WASTES

The number used to define the type of waste is the diameter of the outflow. The sinks are available with 52mm, 60mm or 92mm diameter outflow.

CODE	FINISH	WASTE	PACKAGING
100090601	BRUSHED STEEL	Ø92	CARTON BOX

▶ OVERFLOW

All PYRAMIS sinks are supplied with an overflow as shown on the drawings, for the avoidance of water flooding in cases of closed outflows. The overflow can be either in the bowl or on the drainer of the sink.



▶ PACKAGING

There are two different types of packaging, in a carton box or a sleeve. Carton boxes usually include the valve, siphon and in some cases accessory/ies relevant to the packed sink. Sleeve packaging includes only the sink. The suitable valve(s) and siphon should be ordered separately by the customer.

Waste valves & siphon: In the presentation of individual sink model, you can find the drawing of the suitable waste valve and siphon according to the specifications of the codes appeared. PYRAMIS provides both usual and space saver siphons, as well as usual and pop up valves. For any other case of different sink specifications, from those shown in the presentation page of the model, please check for the suitable waste kit in the table of page 72.

▶ OPTIONAL ACCESSORIES

Apart from the special product sets, where the sink is provided with its own accessories, there are also a variety of specially designed accessories, suitable for the majority of the sinks shown. In this catalogue you can select the suitable accessory of any sink, by its reference code.

▶ PYRAMIS PROPOSED TAP

PYRAMIS provides an extensive range of kitchen taps, certified by the highest quality standards and distinguished by their innovative design. By taking into consideration the particular design of the following sink models, we have tried to match each sink with a complimentary kitchen tap in an attractive combination.

INSTALLATION DRAWINGS

CUT OUT DRAWING

Is a detailed guide which will help you to produce an accurate cut-out in the worktop of the sink. It includes the cut-out length, width and corner radius applicable to the model concerned, including Inset, Undermount or Flush fitting.

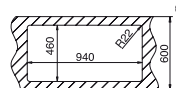

SIPHON INSTALLATION DRAWING

Gives you detailed information and measurements about how the space under the sink is formatted, after the installation of the siphon.

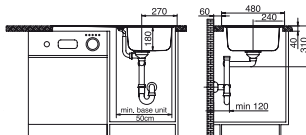

MINIMUM BASE UNIT

Refers to the required worktop length area underneath the installed sink.

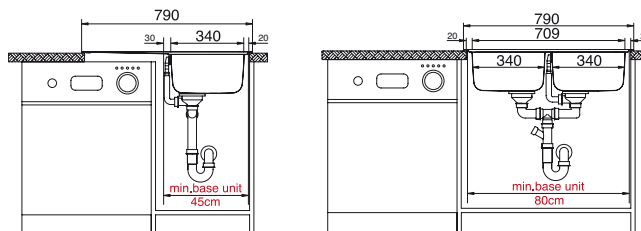

INSTALLATION PROFILE OF SINKS

Illustrates, according to the different installation types, the way that the sink sits on the worktop.



INSTALLATION TYPES

INSET

The rim of the sink after installation appears on the worktop.



UNDERMOUNT

The rim of the sink appears underneath the worktop.



FLUSHMOUNT

The rim of the sink appears at exactly the same level with the worktop.



BENDING TYPES OF ONSET SINKS

BRITISH ROLL FRONT EDGE

Describes the front edge of a British onset sink which is rounded.

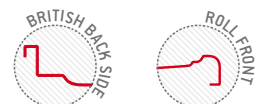

BRITISH SQUARE FRONT EDGE

Is the second version of British onset sink where the two front edges are squared.

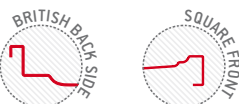

MODULES BENDING TYPE



PYRAMIS

The pure minimalist design of the recessed drainer is both practical and elegant.



A tight corner radius of just 14mm and generous bowl depth of 200mm provide unrivalled space.



STUDIO SERIES ELEGANT

The highest quality materials have been used to create this exceptional, yet functional sink series.



A stunning range of co-ordinated accessories add to the overall aesthetic.

STUDIO (116X50) 2B 1D RIGHT HAND DRAINER

CODE	FINISH	TAP HOLES	WASTE	PACKAGING
107146830	SMOOTH	2	Ø92	1 ITEM PER CARTON BOX

Carton box includes: Pop up waste valve, waste valve & siphon.



• Bowl Overflow

• Sink Dimensions:
1160 x 500mm

• Bowl Dimensions:
400 x 400 x 200mm
300 x 340 x 170mm



Installation drawings

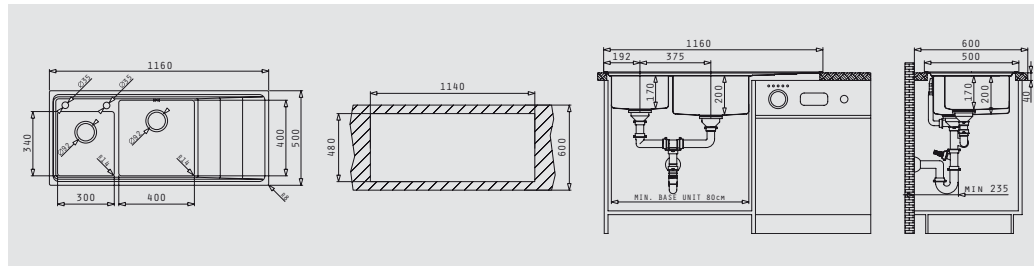

Optional accessories ▶



Proposed tap



MAESTRO

Included waste valves & siphon

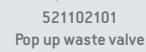

STUDIO (116X50) 2B 1D LEFT HAND DRAINER

CODE	FINISH	TAP HOLES	WASTE	PACKAGING
107146530	SMOOTH	2	Ø92	1 ITEM PER CARTON BOX

Carton box includes: Pop up waste valve, waste valve & siphon.



• Bowl Overflow

• Sink Dimensions:
1160 x 500mm

• Bowl Dimensions:
400 x 400 x 200mm
300 x 340 x 170mm



Installation drawings

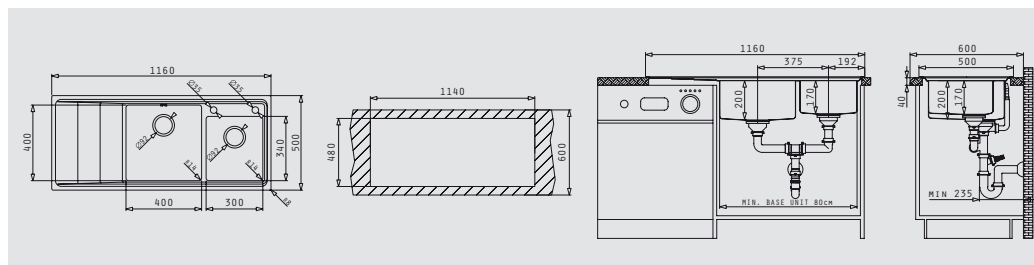

Optional accessories ▶



Proposed tap



MAESTRO

Included waste valves & siphon

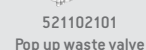

PYRAMIS

STUDIO (100X50) 1 1/2B 1D RIGHT HAND DRAINER

CODE	FINISH	TAP HOLES	WASTE	PACKAGING
107146630	SMOOTH	2	Ø92	1 ITEM PER CARTON BOX

Carton box includes: Pop up waste valve, waste valve & siphon.



•Bowl Overflow

•Sink Dimensions:
1000 x 500mm

•Bowl Dimensions:
340 x 400 x 200mm
170 x 300 x 140mm



Installation drawings

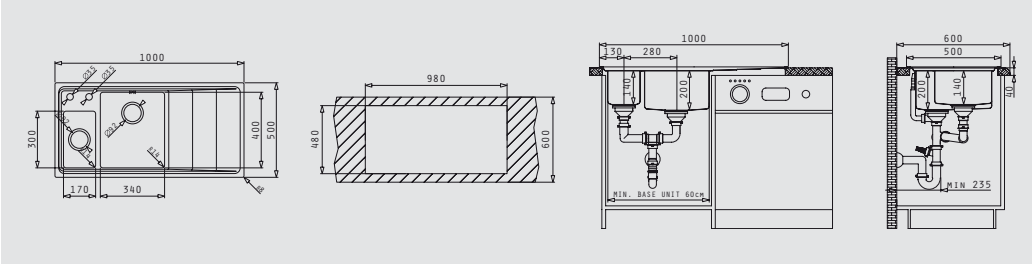

Optional accessories ▶



Proposed tap



AVRA

Included waste valves & siphon



521097201
Waste valve



521102101
Pop up waste valve

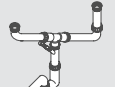

521055201
Siphon

STUDIO (100X50) 1 1/2B 1D LEFT HAND DRAINER

CODE	FINISH	TAP HOLES	WASTE	PACKAGING
107146430	SMOOTH	2	Ø92	1 ITEM PER CARTON BOX

Carton box includes: Pop up waste valve, waste valve & siphon.



•Bowl Overflow

•Sink Dimensions:
1000 x 500mm

•Bowl Dimensions:
340 x 400 x 200mm
170 x 300 x 140mm



Installation drawings

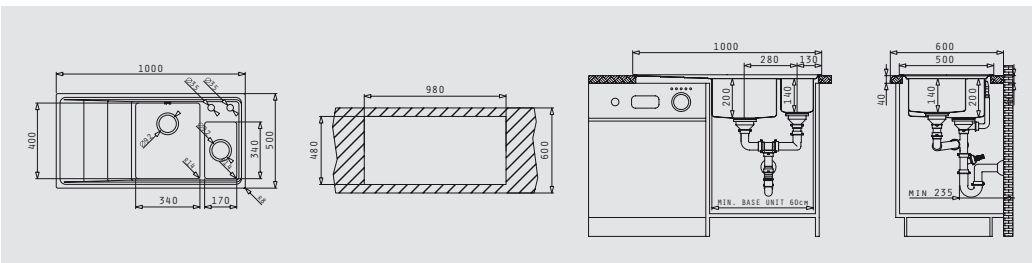

Optional accessories ▶



Proposed tap



MUSA

Included waste valves & siphon



521097201
Waste valve



521102101
Pop up waste valve

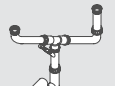

521055201
Siphon

STUDIO (86X50) 1B 1D RIGHT HAND DRAINER

CODE	FINISH	TAP HOLES	WASTE	PACKAGING
107146730	SMOOTH	2	Ø92	1 ITEM PER CARTON BOX

Carton box includes: Pop up waste valve & siphon.

Optional accessories ▶



STEEL COLANDER
043000501



GLASS CHOPPING BOARD
043000601



•Bowl Overflow

•Sink Dimensions:
860 x 500mm

•Bowl Dimensions:
400 x 400 x 200mm

Proposed tap



SYMETRIA



Installation drawings

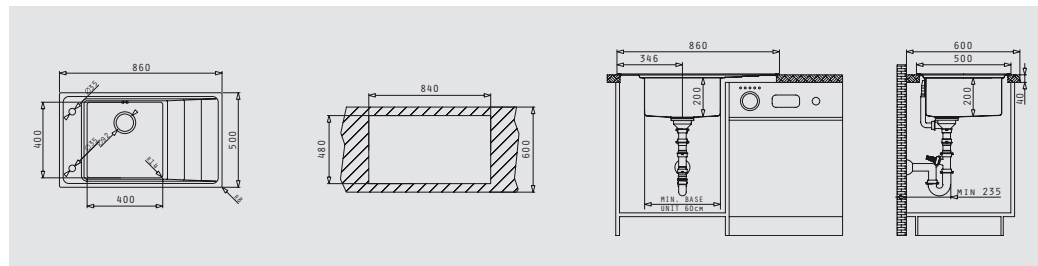

Included waste valve & siphon



521102101
Pop up waste valve



521055801
Siphon

STUDIO (86X50) 1B 1D LEFT HAND DRAINER

CODE	FINISH	TAP HOLES	WASTE	PACKAGING
107146230	SMOOTH	2	Ø92	1 ITEM PER CARTON BOX

Carton box includes: Pop up waste valve & siphon.

Optional accessories ▶



STEEL COLANDER
043000501



GLASS CHOPPING BOARD
043000601



•Bowl Overflow

•Sink Dimensions:
860 x 500mm

•Bowl Dimensions:
400 x 400 x 200mm

Proposed tap



SYMETRIA



Installation drawings

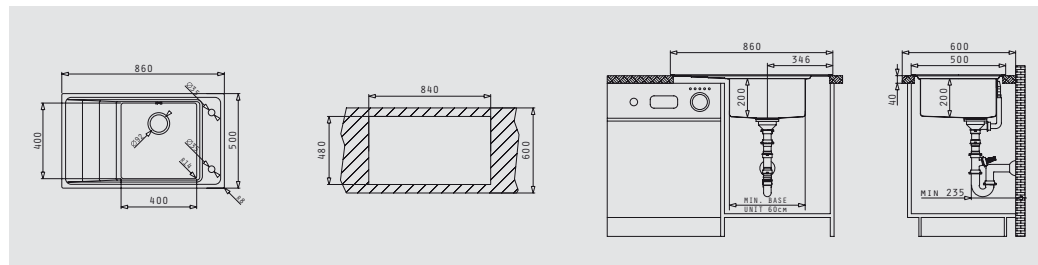

Included waste valve & siphon



521102101
Pop up waste valve

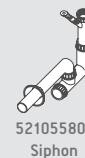

521055801
Siphon

PYRAMIS

STUDIO (86X50) 2B BIG BOWL LEFT

CODE	FINISH	TAP HOLES	WASTE	PACKAGING
107146330	SMOOTH	2	Ø92	1 ITEM PER CARTON BOX

Carton box includes: Pop up waste valve, waste valve & siphon.



•Bowl Overflow

•Sink Dimensions:
860 x 500mm

•Bowl Dimensions:
450 x 400 x 200mm
300 x 340 x 170mm



Proposed tap



AVRA

Optional accessories ▶



STEEL
COLANDER
043000501



GLASS CHOPPING
BOARD
043000601

Installation drawings

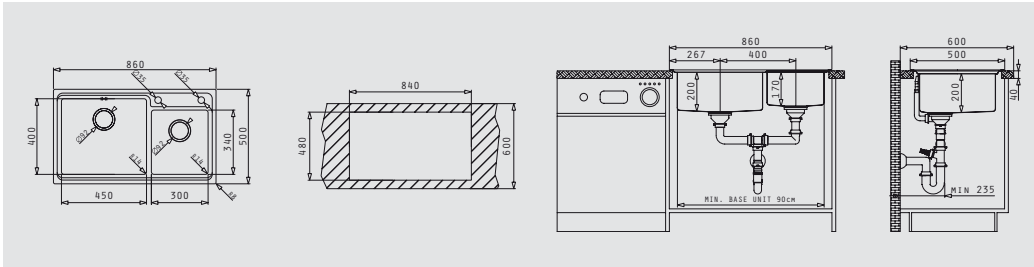

Included waste valves & siphon



521097201
Waste valve



521102101
Pop up waste valve

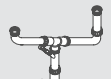

521055201
Siphon

*The Crystalon sink is available
with a complete range of matching
accessories.*

*The stunning look of
the beautiful tempered
glass drainer is perfectly
complemented by smart
stainless steel bowls; each
with a small corner radius.*



CRYSTALON SERIES

ELEGANT

*Pyramis offers a revolutionary new approach
to the sink with its beautiful Crystalon series.
Breaking away from traditional concepts, this
combines high quality tempered black glass
with 18/10 stainless steel bowls.*



PYRAMIS

CRYSTALON (116X52) 2B 1D RIGHT HAND DRAINER

CODE	FINISH	TAP HOLES	WASTE	PACKAGING
101002631	BRUSHED STEEL & GLASS	2	Ø92	1 ITEM PER CARTON BOX

Carton box includes: Pop up waste valve, waste valve & siphon.



•Bowl Overflow

•Sink Dimensions:
1160 x 520mm

•Bowl Dimensions:
340 x 400 x 200mm
340 x 400 x 200mm



Installation drawings

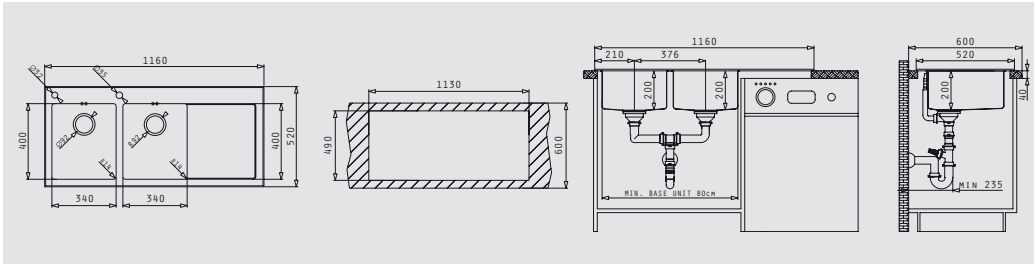

Optional accessories ▶



Proposed tap



Included waste valves & siphon

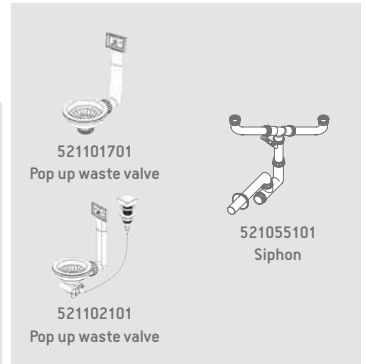

CRYSTALON (116X52) 2B 1D LEFT HAND DRAINER

CODE	FINISH	TAP HOLES	WASTE	PACKAGING
101002731	BRUSHED STEEL & GLASS	2	Ø92	1 ITEM PER CARTON BOX

Carton box includes: Pop up waste valve, waste valve & siphon.



•Bowl Overflow

•Sink Dimensions:
1160 x 520mm

•Bowl Dimensions:
340 x 400 x 200mm
340 x 400 x 200mm



Installation drawings

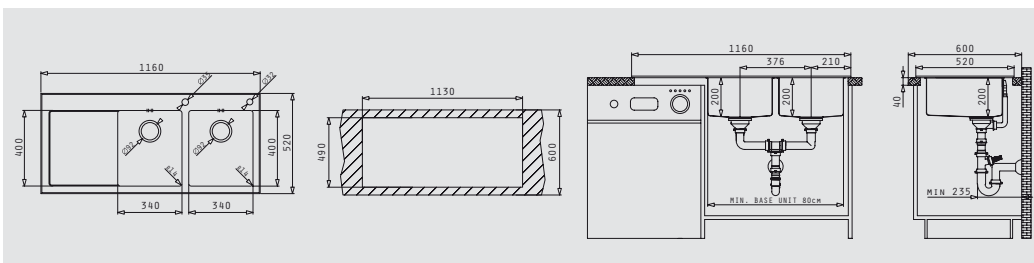

Optional accessories ▶



Proposed tap



Included waste valves & siphon

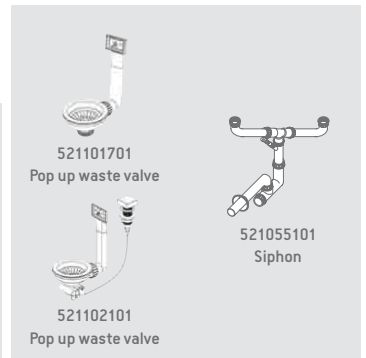

CRYSTALON (100X52) 1 1/2B 1D RIGHT HAND DRAINER

CODE	FINISH	TAP HOLES	WASTE	PACKAGING
101002431	BRUSHED STEEL & GLASS	2	Ø92	1 ITEM PER CARTON BOX

Carton box includes: Pop up waste valve, waste valve & siphon.

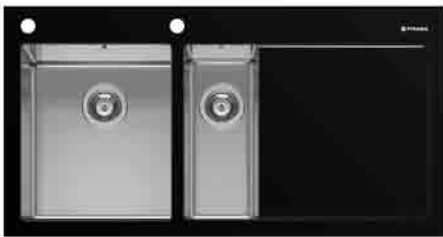

•Bowl Overflow

•Sink Dimensions:
1000 x 520mm

•Bowl Dimensions:
340 x 400 x 200mm
170 x 400 x 140mm



Proposed tap



SYMETRIA

Optional accessories ▶



STEEL COLANDER
043000501



GLASS CHOPPING BOARD
043000201

Installation drawings

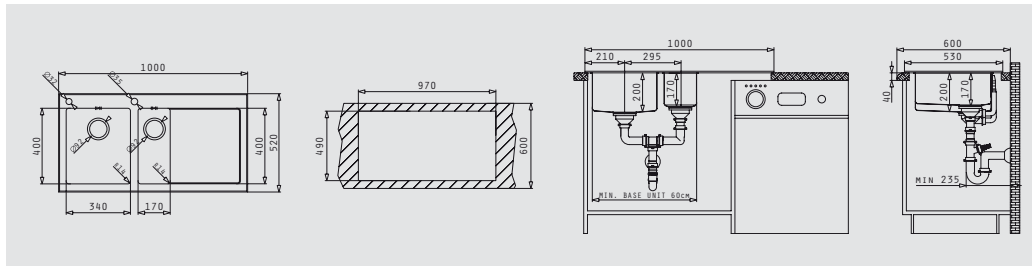

Included waste valves & siphon

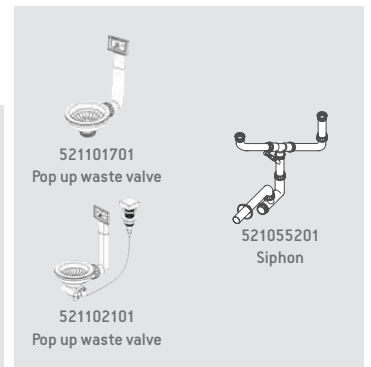

CRYSTALON (100X52) 1 1/2B 1D LEFT HAND DRAINER

CODE	FINISH	TAP HOLES	WASTE	PACKAGING
101002531	BRUSHED STEEL & GLASS	2	Ø92	1 ITEM PER CARTON BOX

Carton box includes: Pop up waste valve, waste valve & siphon.



•Bowl Overflow

•Sink Dimensions:
1000 x 520mm

•Bowl Dimensions:
340 x 400 x 200mm
170 x 400 x 140mm



Proposed tap



SYMETRIA

Optional accessories ▶



STEEL COLANDER
043000501



GLASS CHOPPING BOARD
043000201

Installation drawings

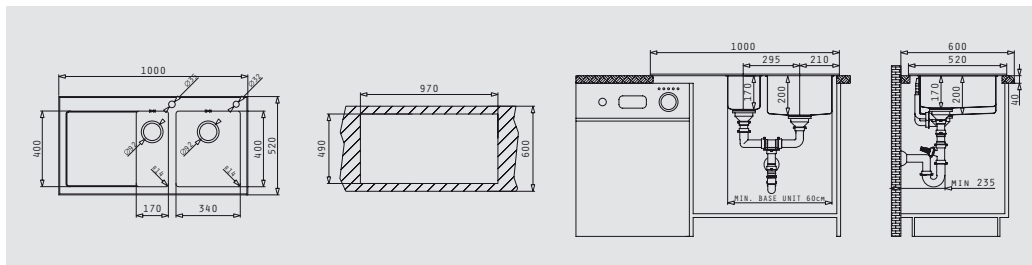

Included waste valves & siphon

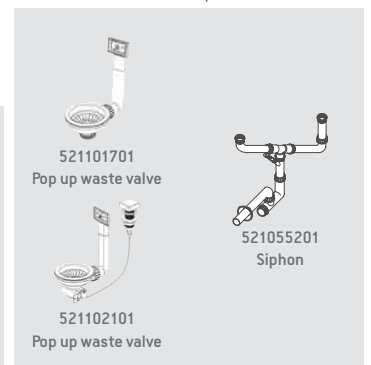

PYRAMIS

CRYSTALON (86X53) 1B 1D RIGHT HAND DRAINER

CODE	FINISH	TAP HOLES	WASTE	PACKAGING
101003831	BRUSHED STEEL & GLASS	2	Ø92	1 ITEM PER CARTON BOX

Carton box includes: Pop up waste valve & siphon.

Optional accessories ▶



•Bowl Overflow

•Sink Dimensions:
860 x 530mm

•Bowl Dimensions:
400 x 400 x 200mm

Proposed tap



Installation drawings

Included waste valve & siphon

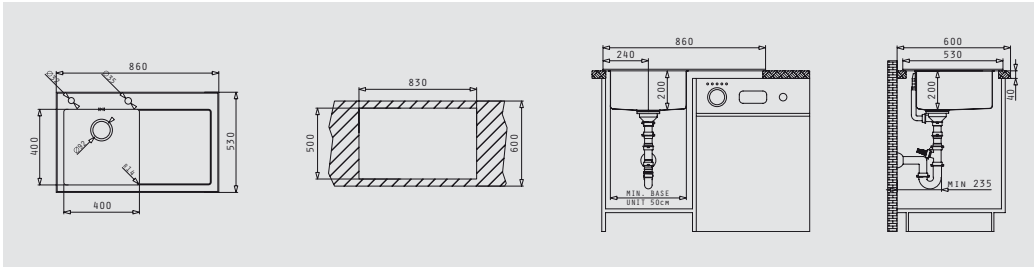

CRYSTALON (86X53) 1B 1D LEFT HAND DRAINER

CODE	FINISH	TAP HOLES	WASTE	PACKAGING
101002331	BRUSHED STEEL & GLASS	2	Ø92	1 ITEM PER CARTON BOX

Carton box includes: Pop up waste valve & siphon.

Optional accessories ▶



•Bowl Overflow

•Sink Dimensions:
860 x 530mm

•Bowl Dimensions:
400 x 400 x 200mm

Proposed tap



Installation drawings

Included waste valve & siphon

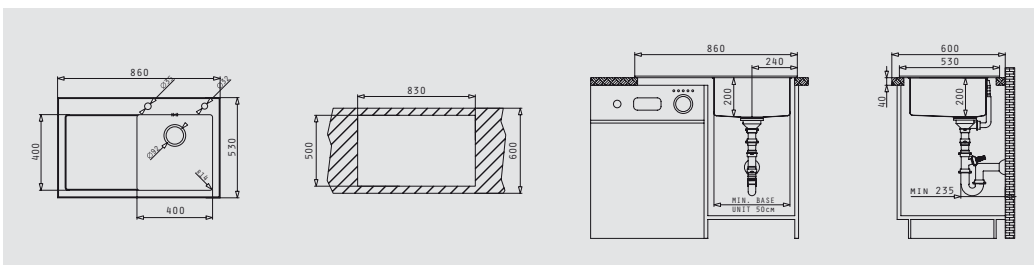

*Extend your workspace with
co-ordinating accessories.*



ASTRIS SERIES ELEGANT

*Designed for those that strive for perfection
in the kitchen, the pure clean lines and variety
of different bowl sizes provide countless
combinations and ultimate versatility.*

*Deep spacious bowls with a
corner radius of just 14mm.*



PYRAMIS

ASTRIS (17X40) 1B

CODE	FINISH	WASTE	INSTALLATION TYPE	PACKAGING
100095101	BRUSHED STEEL	Ø92	UNDERMOUNT	1 ITEM PER CARTON BOX

Carton box includes: Waste valve.

Optional accessories ▶



•Bowl Overflow

•Outer Dimensions:
210 x 440mm

•Bowl Dimensions:
170 x 400 x 140mm

Proposed tap



Installation drawings

Waste valves

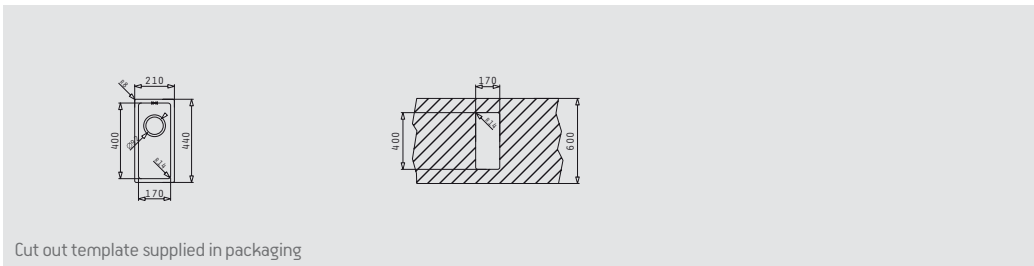

ASTRIS (34X40) 1B

CODE	FINISH	WASTE	INSTALLATION TYPE	PACKAGING
100095001	BRUSHED STEEL	Ø92	UNDERMOUNT	1 ITEM PER CARTON BOX

Carton box includes: Waste valve.

Optional accessories ▶



•Bowl Overflow

•Outer Dimensions:
380 x 440mm

•Bowl Dimensions:
340 x 400 x 200mm

Proposed tap



Installation drawings

Waste valves

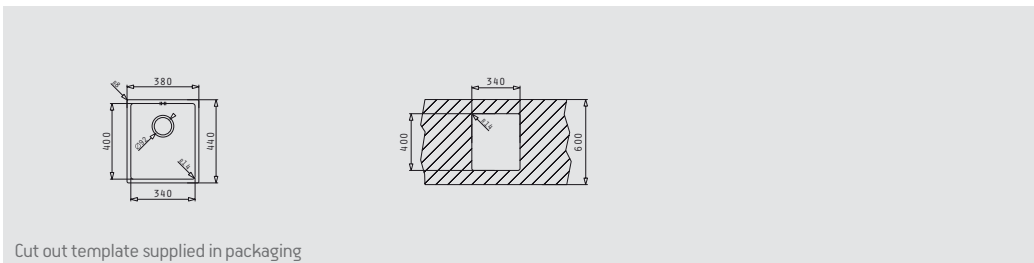

ASTRIS (40X40) 1B

CODE	FINISH	WASTE	INSTALLATION TYPE	PACKAGING
100095201	BRUSHED STEEL	Ø92	UNDERMOUNT	1 ITEM PER CARTON BOX

Carton box includes: Waste valve.

Optional accessories ▶



STEEL COLANDER
043000501



GLASS CHOPPING BOARD
043000201



• Bowl Overflow

• Outer Dimensions:
440 x 440mm

• Bowl Dimensions:
400 x 400 x 200mm

Proposed tap



AVRA



Installation drawings

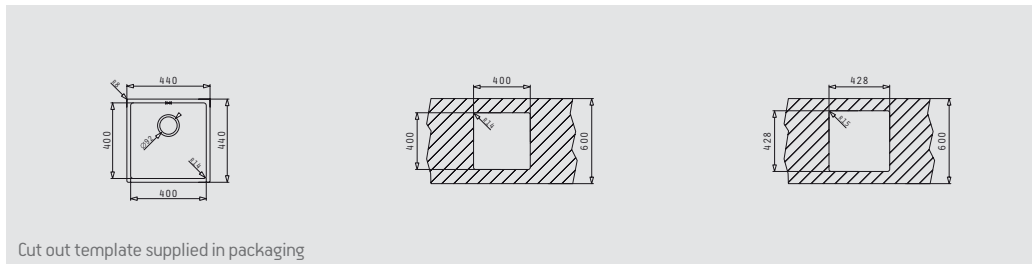

Cut out template supplied in packaging

Waste valves



ASTRIS (45X40) 1B

CODE	FINISH	WASTE	INSTALLATION TYPE	PACKAGING
100095301	BRUSHED STEEL	Ø92	UNDERMOUNT	1 ITEM PER CARTON BOX

Carton box includes: Waste valve.

Optional accessories ▶



STEEL COLANDER
043000501



GLASS CHOPPING BOARD
043000201



• Bowl Overflow

• Outer Dimensions:
490 x 440mm

• Bowl Dimensions:
450 x 400 x 200mm

Proposed tap



MAZORE



Installation drawings

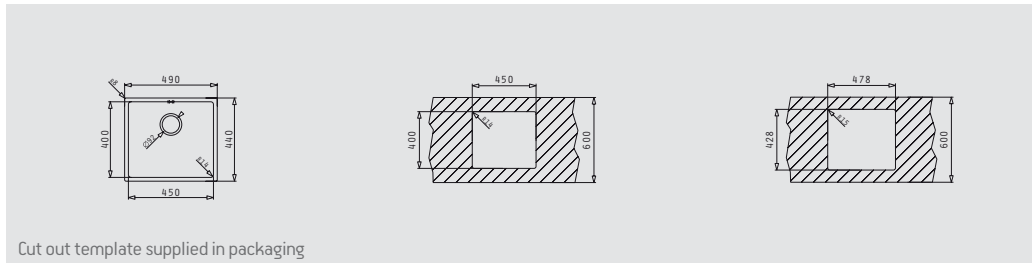

Cut out template supplied in packaging

Waste valves



PYRAMIS

ASTRIS (50X40) 1B

CODE	FINISH	WASTE	INSTALLATION TYPE	PACKAGING
100095401	BRUSHED STEEL	Ø92	UNDERMOUNT	1 ITEM PER CARTON BOX

Carton box includes: Waste valve.

[Optional accessories](#) ▶



•Bowl Overflow

•Outer Dimensions:
540 x 440mm

•Bowl Dimensions:
500 x 400 x 200mm

Proposed tap



SYMETRIA



Installation drawings

Waste valves

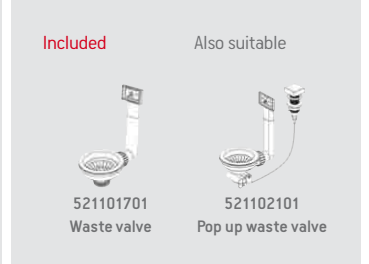
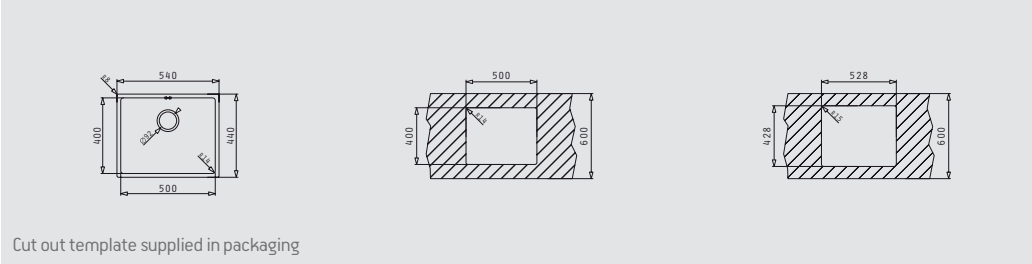

Cut out template supplied in packaging

ASTRIS (74X40) 1B

CODE	FINISH	WASTE	INSTALLATION TYPE	PACKAGING
100095501	BRUSHED STEEL	Ø92	UNDERMOUNT	1 ITEM PER CARTON BOX

Carton box includes: Waste valve.

[Optional accessories](#) ▶



•Bowl Overflow

•Outer Dimensions:
780 x 440mm

•Bowl Dimensions:
740 x 400 x 200mm

Proposed tap



AVRA



Installation drawings

Waste valves

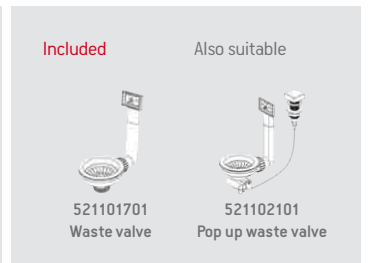
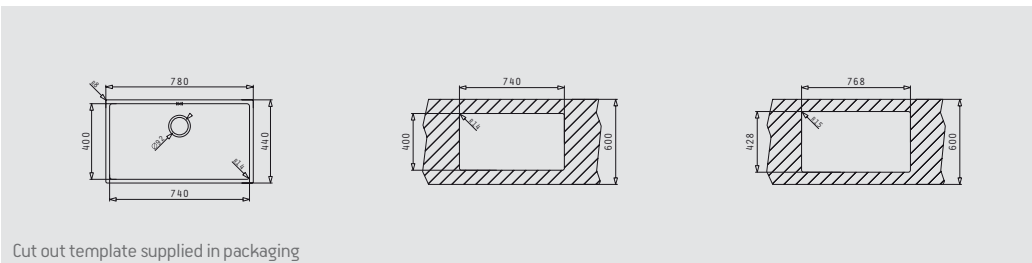

Cut out template supplied in packaging

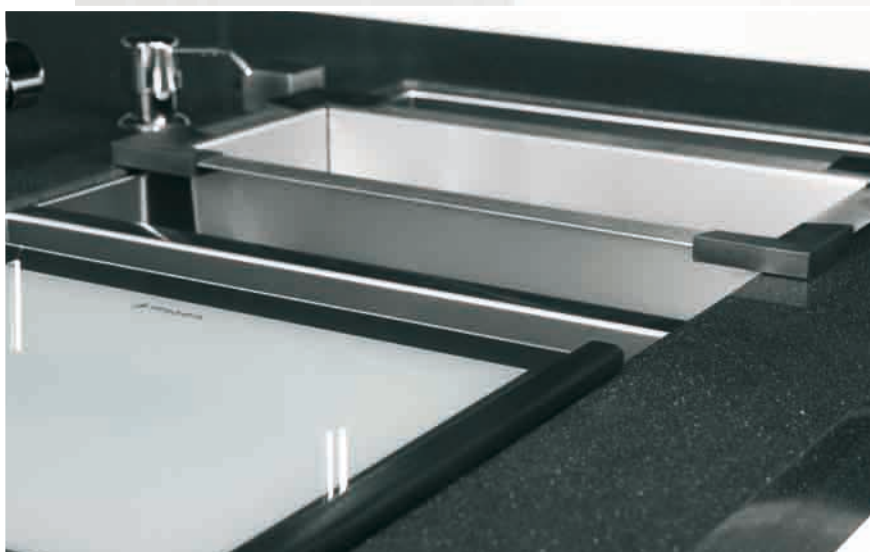

This series of sinks comes with a range of attractive and functional accessories for your washing and cooking preparation area.

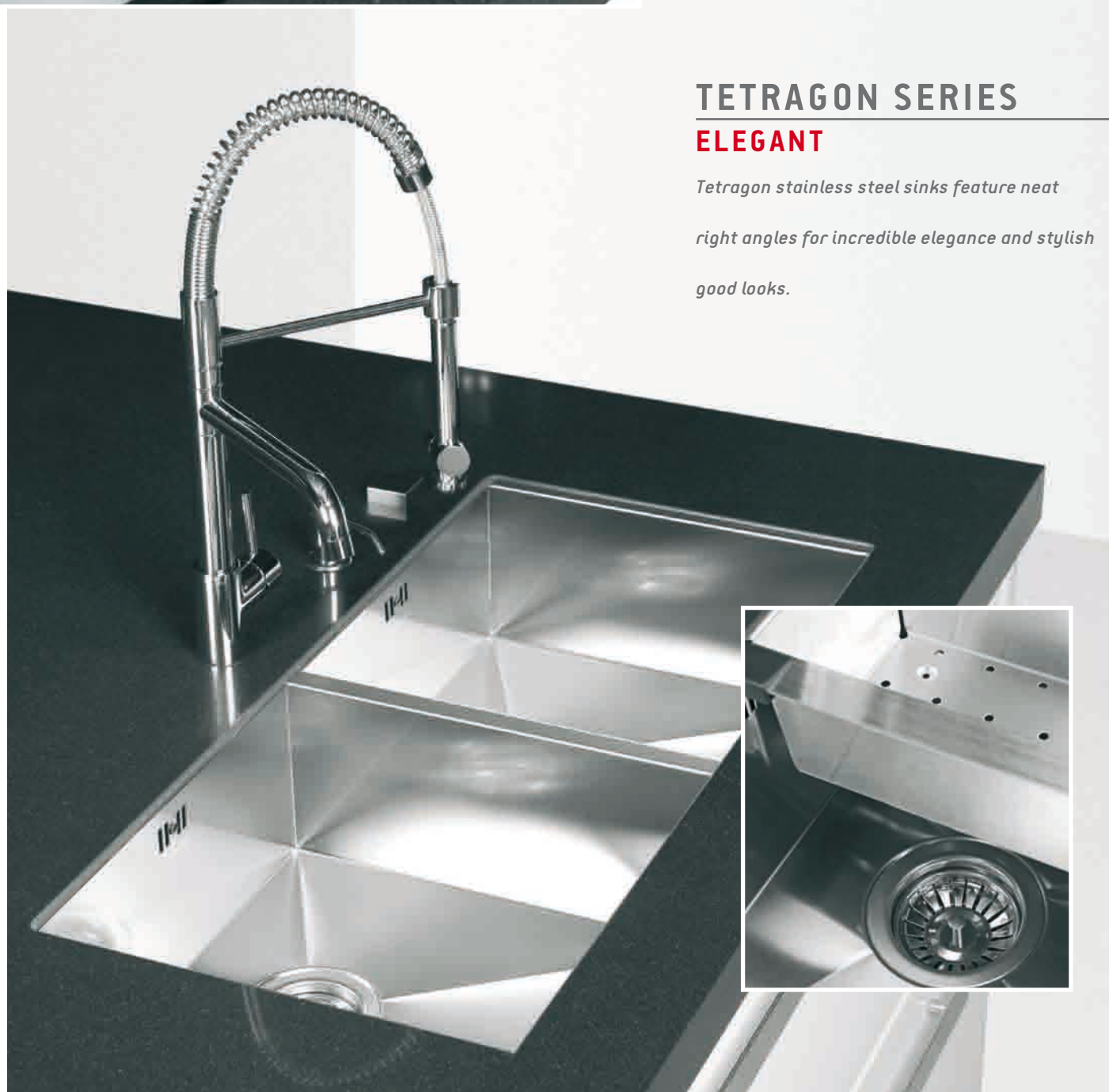

TETRAGON SERIES

ELEGANT

Tetragon stainless steel sinks feature neat right angles for incredible elegance and stylish good looks.

PYRAMIS

TETRAGON (17X40) 1B

CODE	FINISH	WASTE	INSTALLATION TYPE	PACKAGING
100090001	BRUSHED STEEL	Ø92	UNDERMOUNT	1 ITEM PER CARTON BOX

Carton box includes: Waste valve.

Optional accessories ▶



•Bowl Overflow

•Outer Dimensions:
210 x 440mm

•Bowl Dimensions:
170 x 400 x 140mm

Proposed tap



MAZORE



STEEL COLANDER
043000501

Installation drawings

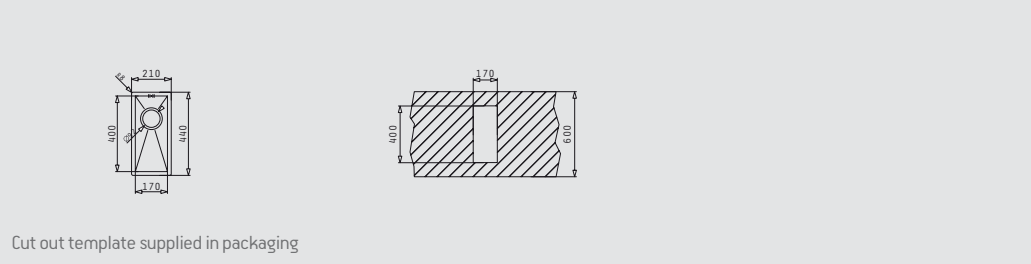

Cut out template supplied in packaging

Waste valves

Included

Also suitable



521101701
Waste valve



521090201
Pop up waste valve

TETRAGON (34X40) 1B

CODE	FINISH	WASTE	INSTALLATION TYPE	PACKAGING
100090101	BRUSHED STEEL	Ø92	UNDERMOUNT	1 ITEM PER CARTON BOX

Carton box includes: Waste valve.

Optional accessories ▶



•Bowl Overflow

•Outer Dimensions:
380 x 440mm

•Bowl Dimensions:
340 x 400 x 200mm

Proposed tap



VERSETO



STEEL COLANDER
043000501



GLASS CHOPPING BOARD
043000201

Installation drawings

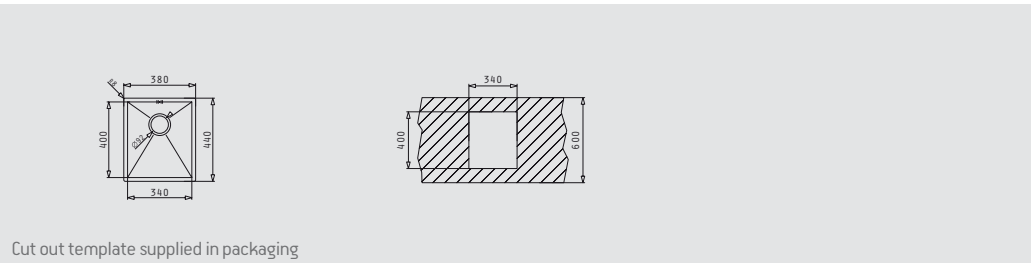

Cut out template supplied in packaging

Waste valves

Included

Also suitable



521101701
Waste valve



521090201
Pop up waste valve

TETRAGON (40X40) 1B

CODE	FINISH	WASTE	INSTALLATION TYPE	PACKAGING
100090201	BRUSHED STEEL	Ø92	UNDERMOUNT	1 ITEM PER CARTON BOX

Carton box includes: Waste valve.

Optional accessories ▶



STEEL COLANDER
043000501



GLASS CHOPPING BOARD
043000201



•Bowl Overflow

•Outer Dimensions:
440 x 440mm

•Bowl Dimensions:
400 x 400 x 200mm

Proposed tap



MAESTRO



Installation drawings

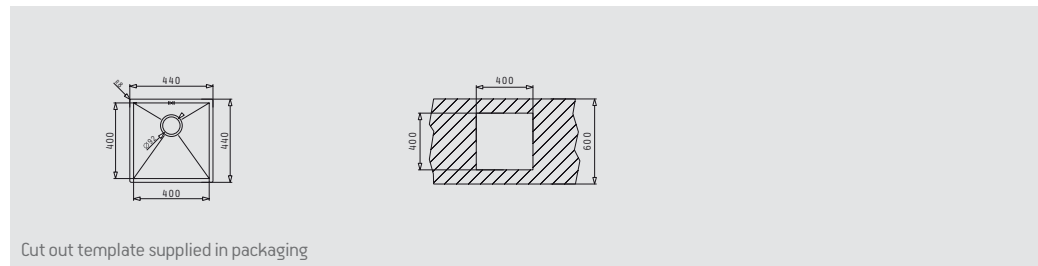

Cut out template supplied in packaging

Waste valves

Included

Also suitable



521101701
Waste valve



521090201
Pop up waste valve

TETRAGON (45X40) 1B

CODE	FINISH	WASTE	INSTALLATION TYPE	PACKAGING
100090301	BRUSHED STEEL	Ø92	UNDERMOUNT	1 ITEM PER CARTON BOX

Carton box includes: Waste valve.

Optional accessories ▶



STEEL COLANDER
043000501



GLASS CHOPPING BOARD
043000201



•Bowl Overflow

•Outer Dimensions:
490 x 440mm

•Bowl Dimensions:
450 x 400 x 200mm

Proposed tap



VERSETO



Installation drawings

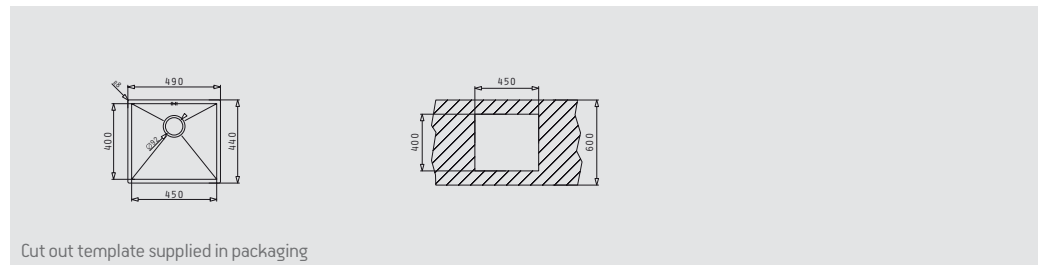

Cut out template supplied in packaging

Waste valves

Included

Also suitable



521101701
Waste valve



521090201
Pop up waste valve

PYRAMIS

TETRAGON (50X40) 1B

CODE	FINISH	WASTE	INSTALLATION TYPE	PACKAGING
100090401	BRUSHED STEEL	Ø92	UNDERMOUNT	1 ITEM PER CARTON BOX

Carton box includes: Waste valve.

Optional accessories ▶



STEEL
COLANDER
043000501



GLASS CHOPPING
BOARD
043000201



•Bowl Overflow

•Outer Dimensions:
540 x 440mm

•Bowl Dimensions:
500 x 400 x 200mm



Proposed tap



MAESTRO

Installation drawings

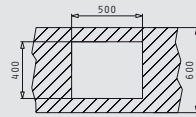
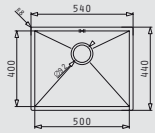

Cut out template supplied in packaging

Waste valves

Included

Also suitable



521101701
Waste valve



521090201
Pop up waste valve

TETRAGON (55X40) 1D

CODE	FINISH	WASTE	INSTALLATION TYPE	PACKAGING
100090501	BRUSHED STEEL	Ø60	UNDERMOUNT	1 ITEM PER CARTON BOX

Carton box includes: Waste valve.

Optional accessories ▶



GLASS CHOPPING
BOARD
043000201



•Outer Dimensions:
590 x 440mm

•Bowl Dimensions:
550 x 400 x 18mm



Installation drawings

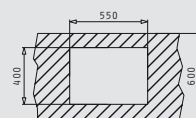
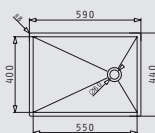

Cut out template supplied in packaging

Waste valve



521100601
Waste valve

TETRAGON (57,5X44) 2B BIG BOWL LEFT

CODE	FINISH	WASTE	INSTALLATION TYPE	PACKAGING
100091530	BRUSHED STEEL	Ø92	UNDERMOUNT	1 ITEM PER CARTON BOX

Carton box includes: Waste valves & space saver siphon.

Optional accessories ▶

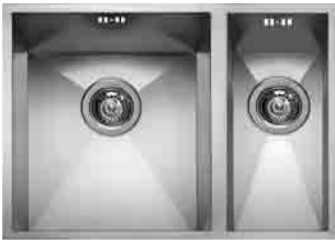

•Bowl Overflow

•Sink Dimensions:
575 x 440mm

•Bowl Dimensions:
340 x 400 x 200mm
170 x 400 x 140mm



Proposed tap



QUADRO



STEEL COLANDER
043000501



GLASS CHOPPING BOARD
043000201

Installation drawing

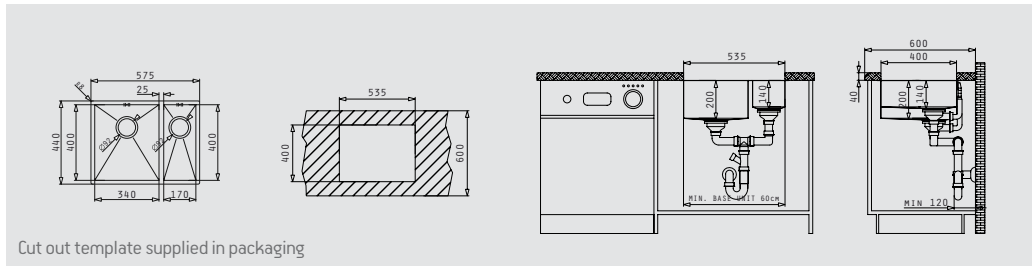

Cut out template supplied in packaging

Waste valves & siphons

Included

Also suitable



521101701
Pop up waste valve



521090201
Pop up waste valve



521058501
Siphon

TETRAGON (57,5X44) 2B BIG BOWL RIGHT

CODE	FINISH	WASTE	INSTALLATION TYPE	PACKAGING
100091430	BRUSHED STEEL	Ø92	UNDERMOUNT	1 ITEM PER CARTON BOX

Carton box includes: Waste valves & space saver siphon.

Optional accessories ▶



•Bowl Overflow

•Sink Dimensions:
575 x 440mm

•Bowl Dimensions:
340 x 400 x 200mm
170 x 400 x 140mm



Proposed tap



VERSETO



STEEL COLANDER
043000501



GLASS CHOPPING BOARD
043000201

Installation drawing

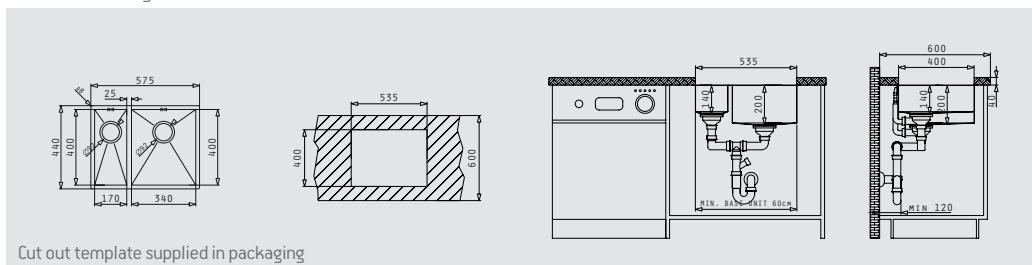

Cut out template supplied in packaging

Waste valves & siphons

Included

Also suitable



521101701
Pop up waste valve



521090201
Pop up waste valve



521058501
Siphon

PYRAMIS

TETRAGON (74,5X44) 2B

CODE	FINISH	WASTE	INSTALLATION TYPE	PACKAGING
100091330	BRUSHED STEEL	Ø92	UNDERMOUNT	1 ITEM PER CARTON BOX

Carton box includes: Waste valves & space saver siphon.



•Bowl Overflow

•Sink Dimensions:
745 x 440mm

•Bowl Dimensions:
340 x 400 x 200mm
340 x 400 x 200mm



Installation drawing

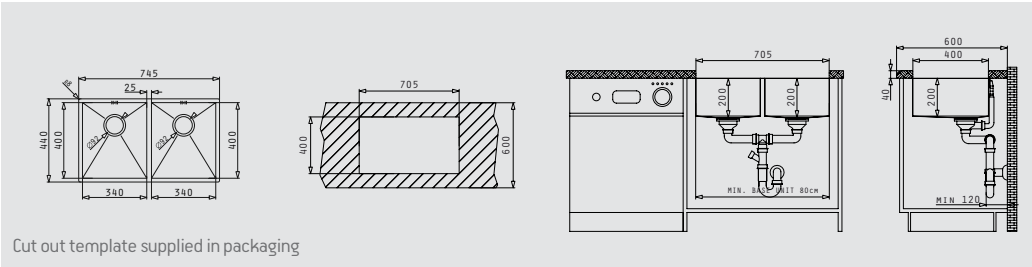

Optional accessories ▶



Proposed tap



MAESTRO

Waste valves & siphons

Included

Also suitable



521101701
Pop up waste valve

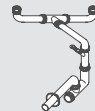

521058401
Siphon



521090201
Pop up waste valve

TETRAGON (86,5X44) 2B

CODE	FINISH	WASTE	INSTALLATION TYPE	PACKAGING
100091230	BRUSHED STEEL	Ø92	UNDERMOUNT	1 ITEM PER CARTON BOX

Carton box includes: Waste valves & space saver siphon.



•Bowl Overflow

•Sink Dimensions:
865 x 440mm

•Bowl Dimensions:
400 x 400 x 200mm
400 x 400 x 200mm



Installation drawing

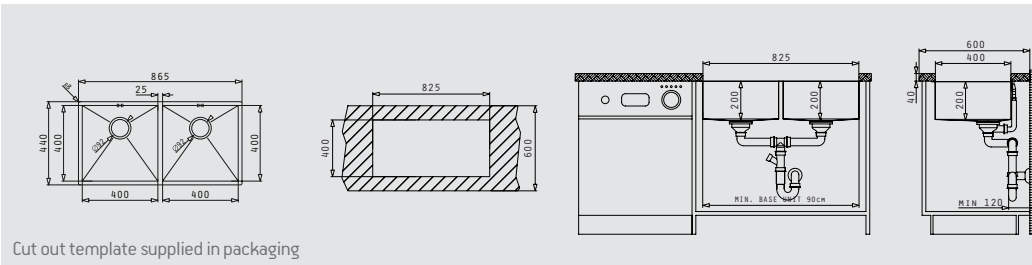

Optional accessories ▶



Proposed tap



ACCORDO

Waste valves & siphons

Included

Also suitable



521101701
Pop up waste valve

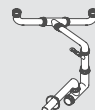

521058401
Siphon



521090201
Pop up waste valve

Cut out template supplied in packaging



DIONE SERIES
PREMIUM

The Dione sinks series features various configurations of different sized two-bowl sinks for undermount installation. Elegant in their simplicity, yet functional in their styling.

DIONE (77X46) 2B UNDERMOUNT

CODE	FINISH	WASTE	PACKAGING
109400630	SMOOTH	Ø92	1 ITEM PER CARTON BOX

Carton box includes: Waste valves, space saver siphon & steel basket.



STEEL BASKET
525004201

Optional accessories ▶



BEECH CHOPPING BOARD
525004701

• Bowl Overflow

• Sink Dimensions:
766 x 456mm

• Bowl Dimensions:
340 x 400 x 180mm
340 x 400 x 180mm

Proposed tap



RIALTO



Installation drawings

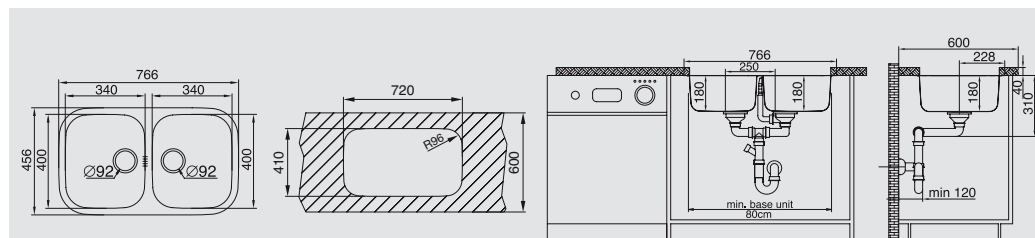

Cut out template supplied in packaging

Waste valves & siphons

Included



521097201



521101701
Waste valves

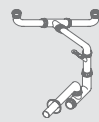

521058401
Space saver siphon

Also suitable



521097201



521090201
Pop up waste valve

PYRAMIS

DIONE (59X46) 1 1/2B LARGE BOWL LEFT UNDERMOUNT



•Bowl Overflow

•Sink Dimensions:
590 x 460mm

•Bowl Dimensions:
340 x 400 x 180mm
165 x 290 x 120mm



Installation drawings

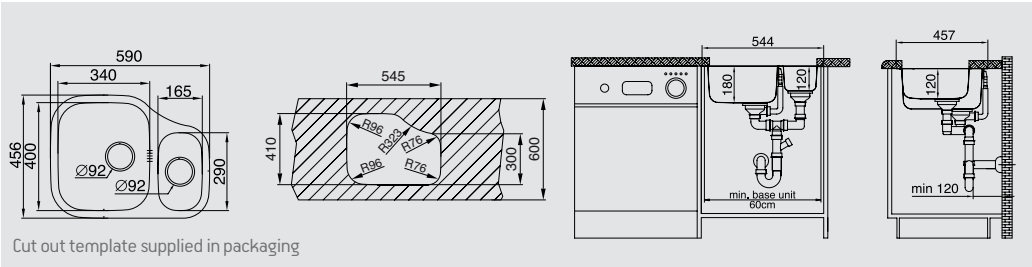

CODE	FINISH	WASTE	PACKAGING
109401030	SMOOTH	Ø92	1 ITEM PER CARTON BOX

Carton box includes: Waste valves, space saver siphon & transparent colander.



Optional accessories ▶



Proposed tap



Waste valves & siphons

Included	Also suitable
521097201	521097201
521101701 Waste valves	521097201
521058501 Space saver siphon	521090201 Pop up waste valve

DIONE (59X46) 1 1/2B LARGE BOWL RIGHT UNDERMOUNT



•Bowl Overflow

•Sink Dimensions:
590 x 460mm

•Bowl Dimensions:
340 x 400 x 180mm
165 x 290 x 120mm

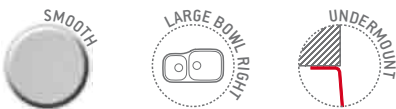

Installation drawings

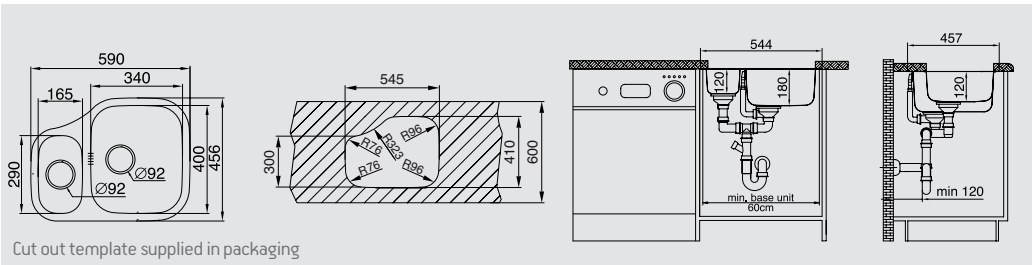

CODE	FINISH	WASTE	PACKAGING
109401330	SMOOTH	Ø92	1 ITEM PER CARTON BOX

Carton box includes: Waste valves, space saver siphon & transparent colander.



Optional accessories ▶



Proposed tap



Waste valves & siphons

Included	Also suitable
521097201	521097201
521101701 Waste valves	521097201
521058501 Space saver siphon	521090201 Pop up waste valve

DIONE (65X40) 1 1/2B LARGE BOWL LEFT UNDERMOUNT

CODE	FINISH	WASTE	PACKAGING
109400430	SMOOTH	Ø92	1 ITEM PER CARTON BOX

Carton box includes: Waste valves, space saver siphon & transparent colander.



•Bowl Overflow

•Sink Dimensions:
649 x 396mm





•Bowl Dimensions:
400 x 340 x 180mm
165 x 290 x 120mm

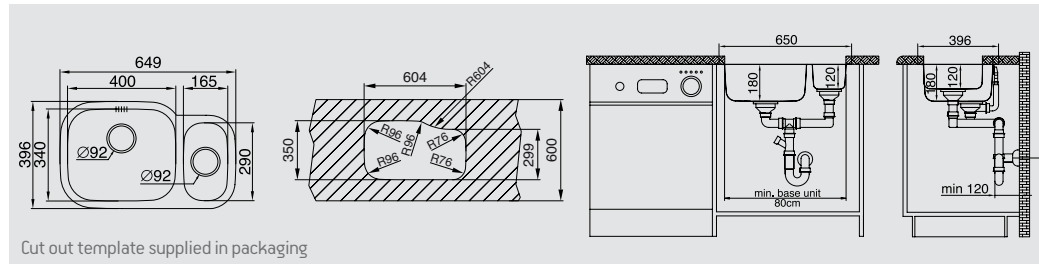

Installation drawings



Optional accessories ▶





 TRANSPARENT COLANDER 525000201	 STEEL BASKET 525004201	 BEECH CHOPPING BOARD 525004701
		 STEEL COLANDER 100060001

Proposed tap



TEMPO

Waste valves & siphons

Included	Also suitable
 521097201	 521097201
 521101701 Waste valves	 521090201 Pop up waste valve
 521058501 Space saver siphon	

DIONE (65X40) 1 1/2B LARGE BOWL RIGHT UNDERMOUNT

CODE	FINISH	WASTE	PACKAGING
109400830	SMOOTH	Ø92	1 ITEM PER CARTON BOX

Carton box includes: Waste valves, space saver siphon & transparent colander.



•Bowl Overflow

•Sink Dimensions:
649 x 396mm





•Bowl Dimensions:
400 x 340 x 180mm
165 x 290 x 120mm

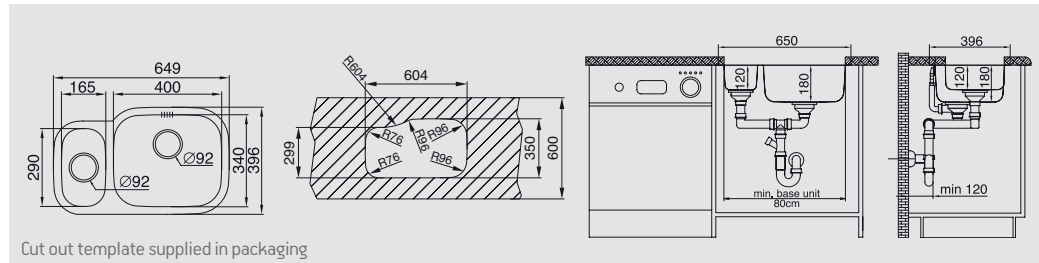

Installation drawings



Optional accessories ▶





 TRANSPARENT COLANDER 525000201	 STEEL BASKET 525004201	 BEECH CHOPPING BOARD 525004701
		 STEEL COLANDER 100060001

Proposed tap



TEMPO

Waste valves & siphons

Included	Also suitable
 521097201	 521097201
 521101701 Waste valves	 521090201 Pop up waste valve
 521058501 Space saver siphon	

PYRAMIS

DIONE (84X46) 2B LARGE BOWL LEFT UNDERMOUNT



•Bowl Overflow

•Sink Dimensions:
838 x 458mm

•Bowl Dimensions:
450 x 400 x 200mm
300 x 340 x 170mm



Installation drawings

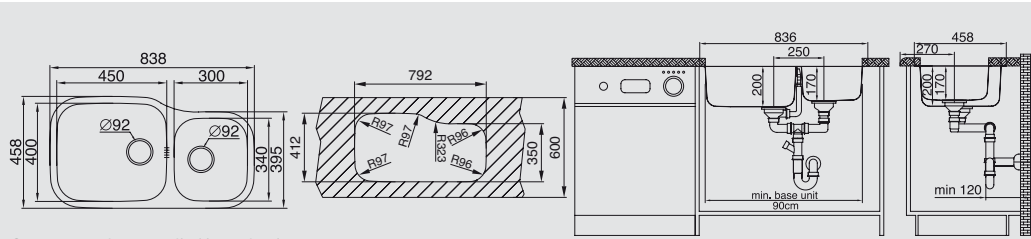

Cut out template supplied in packaging

CODE	FINISH	WASTE	PACKAGING
109400030	SMOOTH	Ø92	1 ITEM PER CARTON BOX

Carton box includes: Waste valves, space saver siphon & steel basket.



STEEL BASKET
525002701

Optional accessories ▶



BEECH CHOPPING BOARD
525005201

Proposed tap



ADAGIO

Waste valves & siphons

Included



Also suitable

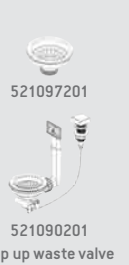

DIONE (84X46) 2B LARGE BOWL RIGHT UNDERMOUNT



•Bowl Overflow

•Sink Dimensions:
838 x 458mm

•Bowl Dimensions:
450 x 400 x 200mm
300 x 340 x 170mm

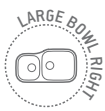

Installation drawings

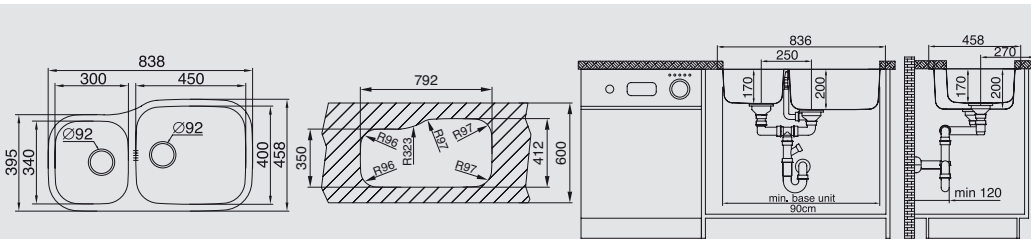

Cut out template supplied in packaging

CODE	FINISH	WASTE	PACKAGING
109400730	SMOOTH	Ø92	1 ITEM PER CARTON BOX

Carton box includes: Waste valves, space saver siphon & steel basket.



STEEL BASKET
525002701

Optional accessories ▶



BEECH CHOPPING BOARD
525005201

Proposed tap



ADAGIO

Waste valves & siphons

Included



Also suitable



DIONE (85X46) 2B LARGE BOWL LEFT UNDERMOUNT

CODE	FINISH	WASTE	PACKAGING
109400530	SMOOTH	Ø92	1 ITEM PER CARTON BOX

Carton box includes: Waste valves, space saver siphon & steel basket.



•Bowl Overflow

•Sink Dimensions:
852 x 457mm

•Bowl Dimensions:
400 x 400 x 200mm
365 x 335 x 150mm



Installation drawings

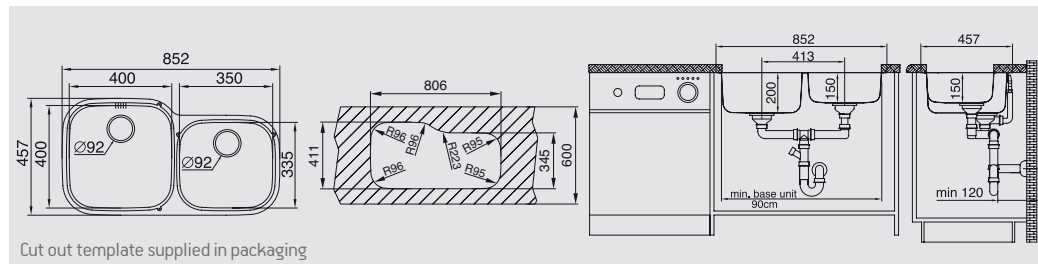

STEEL BASKET
525004101

Optional accessories ▶



BEECH CHOPPING BOARD
525005201

Proposed tap



ACCORDO

Waste valves & siphons

Included	Also suitable
521097201	521097201
521101701 Waste valves	521090201 Pop up waste valve
521058501 Space saver siphon	

DIONE (85X46) 2B LARGE BOWL RIGHT UNDERMOUNT

CODE	FINISH	WASTE	PACKAGING
109400930	SMOOTH	Ø92	1 ITEM PER CARTON BOX

Carton box includes: Waste valves, space saver siphon & steel basket.



•Bowl Overflow

•Sink Dimensions:
852 x 457mm

•Bowl Dimensions:
400 x 400 x 200mm
365 x 335 x 150mm



Installation drawings

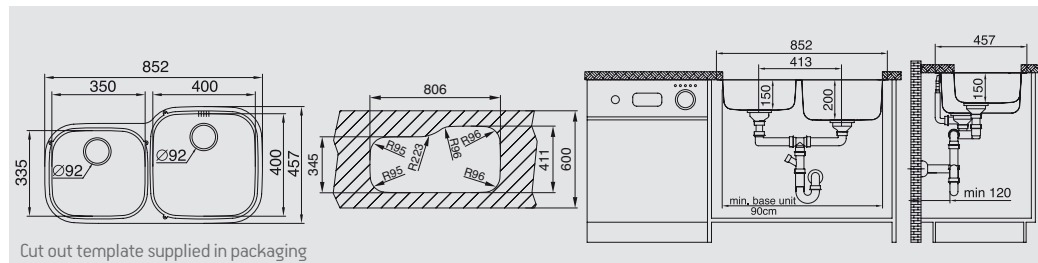

STEEL BASKET
525004101

Optional accessories ▶



BEECH CHOPPING BOARD
525005201

Proposed tap



ACCORDO

Waste valves & siphons

Included	Also suitable
521097201	521097201
521101701 Waste valves	521090201 Pop up waste valve
521058501 Space saver siphon	

PYRAMIS

**DIMITRA SERIES**
PREMIUM

Where style and functionality blend together harmoniously. These stylish sinks each offer a unique perspective for the keen cook, and their attractive designs suit all types of kitchens.



DIMITRA RIGHT HAND DRAINER

CODE	FINISH	TAP HOLES	WASTE	PACKAGING
108772701	SMOOTH	1	Ø92	SLEEVE

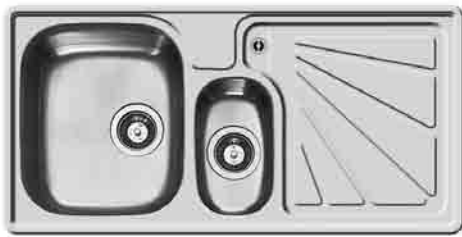

•Drainer Overflow

•Sink Dimensions:
960 x 480mm

•Bowl Dimensions:
340 x 400 x 180mm
165 x 290 x 120mm



Installation drawings

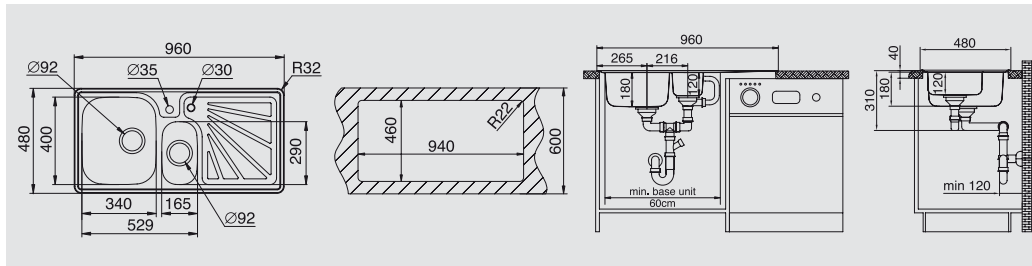

Optional accessories ▶



STEEL COLANDER
100060001



STEEL BASKET
525004201



WHITE BASKET
525000401



TRANSPARENT COLANDER
525000201



BEECH CHOPPING BOARD
525004701

Proposed tap



ACCORDO

Suitable waste valves & siphons

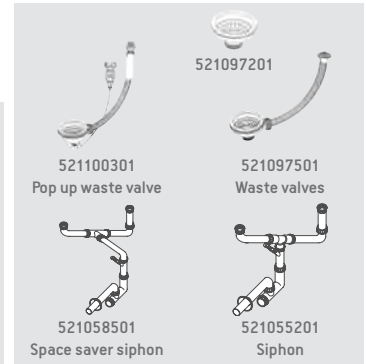

DIMITRA LEFT HAND DRAINER

CODE	FINISH	TAP HOLES	WASTE	PACKAGING
108747701	SMOOTH	1	Ø92	SLEEVE



•Drainer Overflow

•Sink Dimensions:
960 x 480mm

•Bowl Dimensions:
340 x 400 x 180mm
165 x 290 x 120mm



Installation drawings

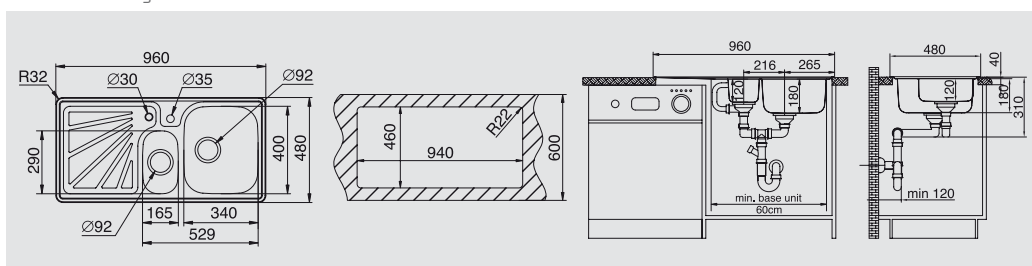

Optional accessories ▶



STEEL COLANDER
100060001



STEEL BASKET
525004201



WHITE BASKET
525000401



TRANSPARENT COLANDER
525000201



BEECH CHOPPING BOARD
525004701

Proposed tap



ACCORDO

Suitable waste valves & siphons

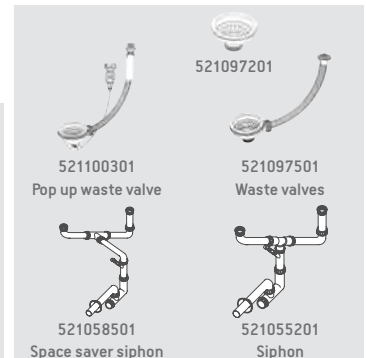



ARIADNE SERIES PREMIUM

Combining straight and curved lines on the drainer together with large-scale bowls of varying dimensions make the design of the Ariadne series of inset sinks one of the most attractive ranges from PYRAMIS.

ARIADNE (79X50) 1B 1D

CODE	FINISH	TAP HOLES	WASTE	DRAINER	PACKAGING
107136901	SMOOTH	1+1	Ø92	REV	SLEEVE



•Bowl Overflow

•Sink Dimensions:
790 x 500mm

•Bowl Dimensions:
340 x 400 x 180mm



Installation drawings

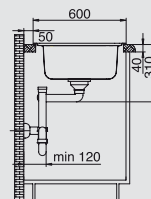
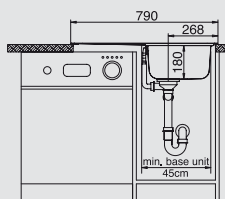
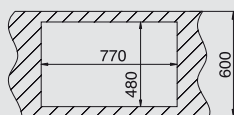
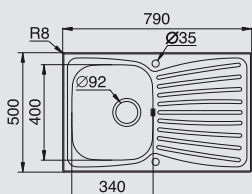

Optional accessories ▶



STEEL BASKET
525004201



WHITE BASKET
525000401



BEECH CHOPPING BOARD
525004701

Proposed tap



MAZORE

Suitable waste valves & siphons



521097301
Waste valve



521097901
Pop up waste valve

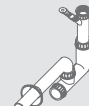

521055801
Siphon

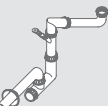

521058301
Space saver siphon

ARIADNE (86X50) 1B 1D

CODE	FINISH	TAP HOLES	WASTE	DRAINER	PACKAGING
107136401	SMOOTH	1+1	Ø92	REV	SLEEVE
107131701	SMOOTH	1	Ø92	LEFT HAND	SLEEVE
107131801	SMOOTH	1	Ø92	RIGHT HAND	SLEEVE



Optional accessories ▶



STEEL BASKET
525004201



WHITE BASKET
525000401



BEECH CHOPPING BOARD
525004701

•Bowl Overflow

•Sink Dimensions:
860 x 500mm

•Bowl Dimensions:
340 x 400 x 180mm

Proposed tap



ADAGIO



Installation drawings

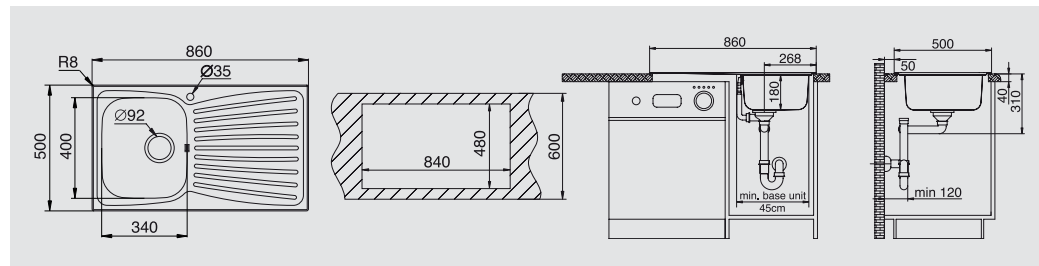

Suitable waste valves & siphons



521097301
Waste valve



521097901
Pop up waste valve



521055801
Siphon

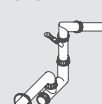

521058301
Space saver siphon

ARIADNE (100X50) 1 1/2B 1D

CODE	FINISH	TAP HOLES	WASTE	DRAINER	PACKAGING
107136501	SMOOTH	1+1	Ø92	REV	1 ITEM PER CARTON BOX
107131901	SMOOTH	1	Ø92	LEFT HAND	1 ITEM PER CARTON BOX
107132001	SMOOTH	1	Ø92	RIGHT HAND	1 ITEM PER CARTON BOX



Optional accessories ▶



STEEL COLANDER
100060001



STEEL BASKET
525004201



WHITE BASKET
525000401

•Bowl Overflow

•Sink Dimensions:
1000 x 500mm

•Bowl Dimensions:
340 x 400 x 180mm
165 x 290 x 120mm

Proposed tap



TEMPO



Installation drawings

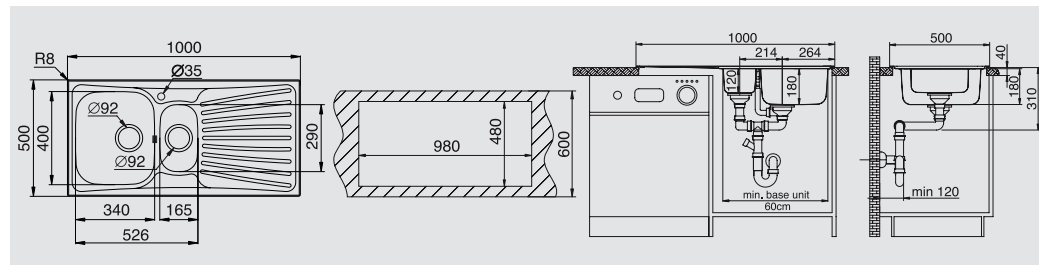

Suitable waste valves & siphons



521097901
Pop up waste valve



521097201
521097301
Waste valves



521058501
Space saver siphon

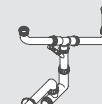

521055201
Siphon



PYRAMIS



**TITAN SERIES
PREMIUM**

Reflective of its name, this is a generously proportioned sink series for larger kitchens and for those that require extra preparation space. Robust, yet with a smooth finish, this attractive range has a timeless appeal. Exclusive to the PYRAMIS Premium collection.

TITAN 1B

CODE	FINISH	TAP HOLES	WASTE	PACKAGING
100138201	SMOOTH	1	Ø92	SLEEVE



Optional accessories ▶



STEEL BASKET
525005401



MAHOGANY CHOPPING BOARD
525005501



SOAP DISPENSER
028101001

•Bowl Overflow

•Sink Dimensions:
860 x 500mm

•Bowl Dimensions:
750 x 415 x 210mm

Proposed tap



ARMONIA

Suitable waste valves & siphons



521097901
Pop up waste valve



521097301
Waste valve

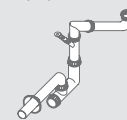

521058301
Space saver siphon

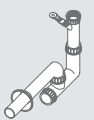

521055801
Siphon

Installation drawings

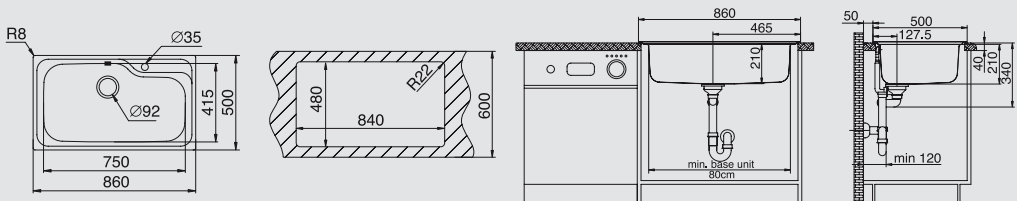



AMALTIA SERIES PREMIUM

The basic idea of the Amaltia series is that sinks should not just optimise space, but also be stylish and functional. Amaltia is a complete range of sinks in a number of configurations of deep bowls and attractively designed drainers.

AMALTIA (62X50) 1 1/2B

CODE	FINISH	TAP HOLES	WASTE	DRAINER	PACKAGING
107132301	SMOOTH	1	Ø92	LEFT HAND	SLEEVE
107132401	SMOOTH	1	Ø92	RIGHT HAND	SLEEVE



• Bowl Overflow

• Sink Dimensions:
620 x 500mm

• Bowl Dimensions:
340 x 400 x 180mm
165 x 290 x 120mm



Installation drawings

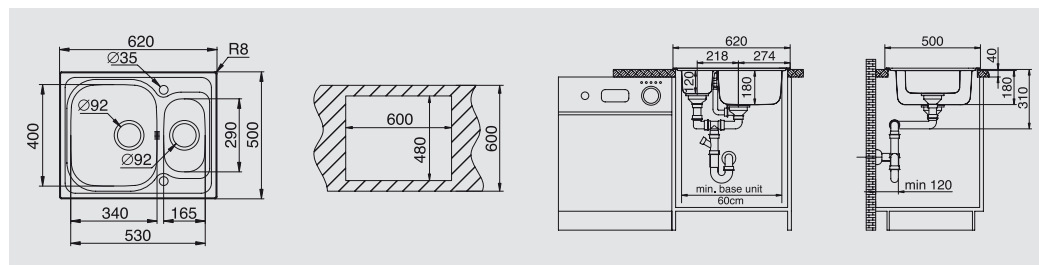

Optional accessories ▶



STEEL
COLANDER
100060001



STEEL
BASKET
525004201



WHITE
BASKET
525000401



TRANSPARENT
COLANDER
525000201



BEECH CHOPPING
BOARD
525004701

Proposed tap



RIALTO

Suitable waste valves & siphons

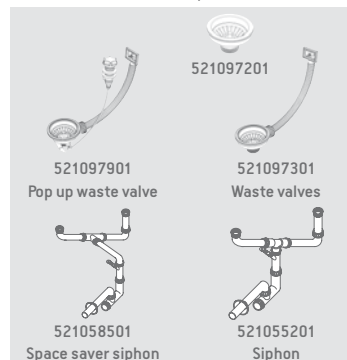

PYRAMIS

AMALTIA (86X50) 1B 1D



•Bowl Overflow

•Sink Dimensions:
860 x 500mm

•Bowl Dimensions:
340 x 400 x 180mm

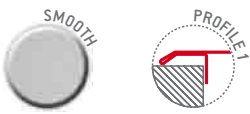

Installation drawings

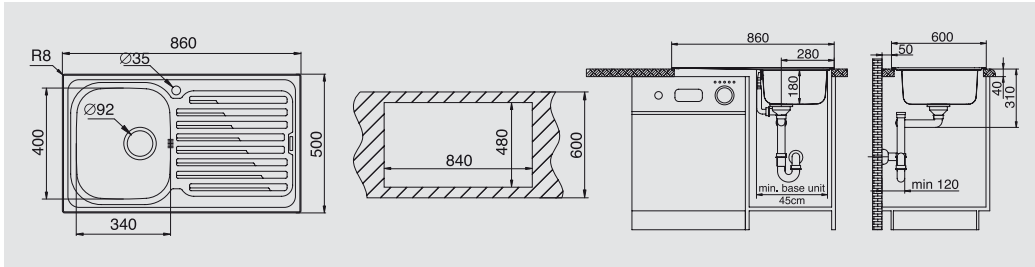

CODE	FINISH	TAP HOLES	WASTE	DRAINER	PACKAGING
107120501	SMOOTH	1+1	Ø92	REV	SLEEVE
107122601	SMOOTH	1	Ø92	LEFT HAND	SLEEVE
107122701	SMOOTH	1	Ø92	RIGHT HAND	SLEEVE

Optional accessories ▶



STEEL BASKET
525004201



WHITE BASKET
525000401



BEECH CHOPPING BOARD
525004701

Proposed tap



TEMPO

Suitable waste valves & siphons



521097901
Pop up waste valve



521097301
Waste valve

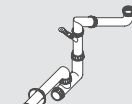

521058301
Space saver siphon

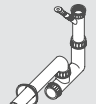

521055801
Siphon

AMALTIA (86X50) 2B



•Bowl Overflow

•Sink Dimensions:
860 x 500mm

•Bowl Dimensions:
340 x 400 x 180mm
340 x 400 x 180mm



Installation drawings

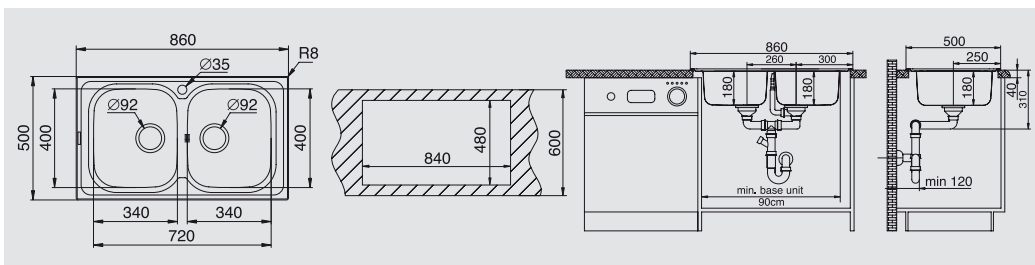

CODE	FINISH	TAP HOLES	WASTE	PACKAGING
107132601	SMOOTH	1	Ø92	SLEEVE

Optional accessories ▶



STEEL BASKET
525004201



WHITE BASKET
525000401



BEECH CHOPPING BOARD
525004701

Proposed tap



RIALTO

Suitable waste valves & siphons



521097901
Pop up waste valve

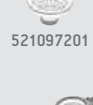

521097201
Waste valves



521058401
Space saver siphon



521055101
Siphon

AMALTA (100X50) 1 1/2B 1D

CODE	FINISH	TAP HOLES	WASTE	DRAINER	PACKAGING
107121401	SMOOTH	1+1	Ø92	REV	SLEEVE
107124401	SMOOTH	1	Ø92	LEFT HAND	SLEEVE
107124501	SMOOTH	1	Ø92	RIGHT HAND	SLEEVE

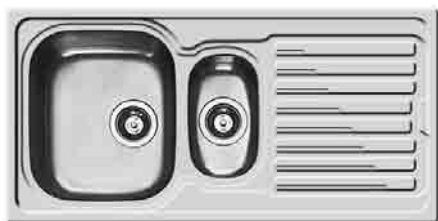

•Bowl Overflow

•Sink Dimensions:
1000 x 500mm

•Bowl Dimensions:
340 x 400 x 180mm
165 x 290 x 120mm



Installation drawings

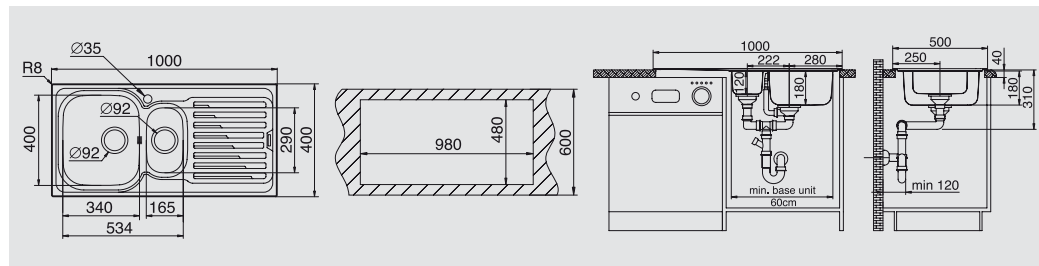

Optional accessories ▶



STEEL COLANDER
100060001



STEEL BASKET
525004201



WHITE BASKET
525000401



TRANSPARENT COLANDER
525000201



BEECH CHOPPING BOARD
525004701

Proposed tap



TEMPO

Suitable waste valves & siphons

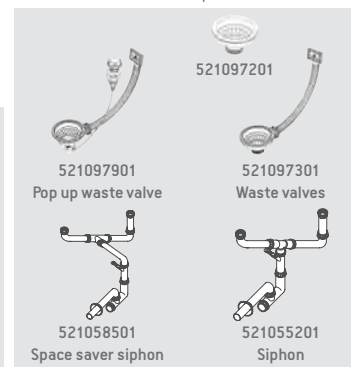

AMALTA (116X50) 2B 1D

CODE	FINISH	TAP HOLES	WASTE	DRAINER	PACKAGING
107122501	SMOOTH	1	LEFT HAND	SLEEVE	
107122401	SMOOTH	1	Ø92	RIGHT HAND	SLEEVE

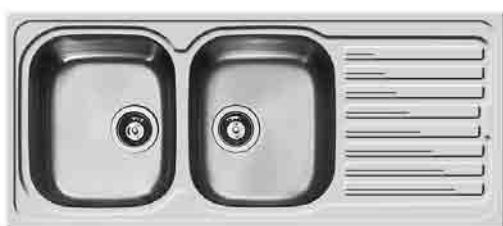

•Bowl Overflow

•Sink Dimensions:
1160 x 500mm

•Bowl Dimensions:
340 x 400 x 180mm
340 x 400 x 180mm



Installation drawings

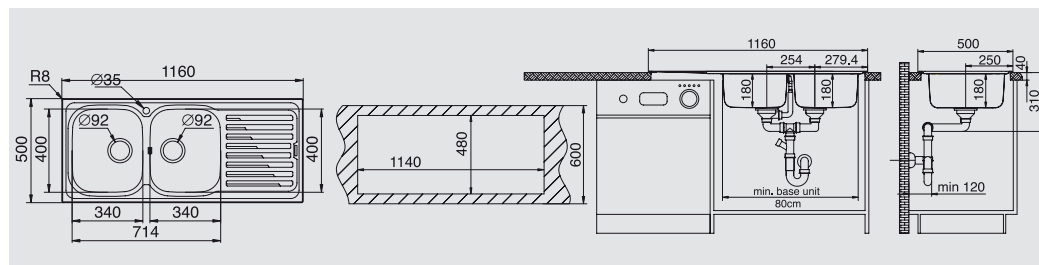

Optional accessories ▶



STEEL BASKET
525004201



WHITE BASKET
525000401



BEECH CHOPPING BOARD
525004701

Proposed tap



ARMONIA

Suitable waste valves & siphons

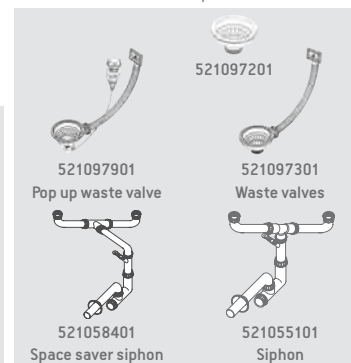



**AMALTIA PLUS SERIES
PREMIUM**

Inspired by the excellent design of the Amaltia series, the Amaltia Plus range offers similar versatility with even greater bowl capacities. Clever combinations of varying size bowls, provides the ultimate in functionality.

AMALTIA PLUS 1B 1D

CODE	FINISH	TAP HOLES	WASTE	DRAINER	PACKAGING
107132701	SMOOTH	1	Ø92	LEFT HAND	SLEEVE
107132801	SMOOTH	1	Ø92	RIGHT HAND	SLEEVE



Optional accessories ▶



BEECH CHOPPING BOARD
525005201

•Bowl Overflow

•Sink Dimensions:
1000 x 500mm

•Bowl Dimensions:
500 x 400 x 200mm

Proposed tap



TEMPO

Suitable waste valves & siphons



521097901
Pop up waste valve



521097301
Waste valve

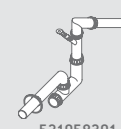

521058301
Space saver siphon

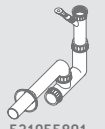

521055801
Siphon

Installation drawings

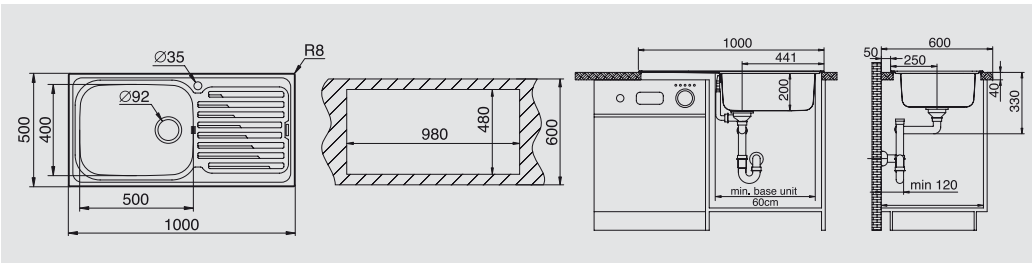

AMALTA PLUS 2B 1D RIGHT HAND DRAINER

CODE	FINISH	TAP HOLES	WASTE	PACKAGING
107133101	SMOOTH	1	Ø92	SLEEVE



•Bowl Overflow

•Sink Dimensions:
1160 x 500mm

•Bowl Dimensions:
450 x 400 x 200mm
300 x 340 x 170mm



Installation drawings

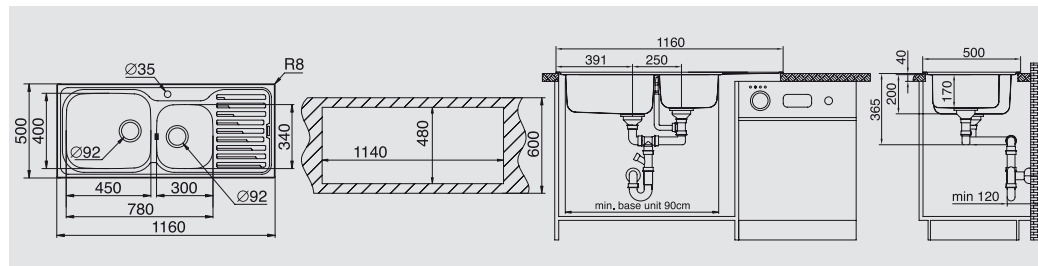

Optional accessories ▶



STEEL BASKET
525002701



BEECH CHOPPING BOARD
525005201

Proposed tap



ARMONIA

Suitable waste valves & siphons

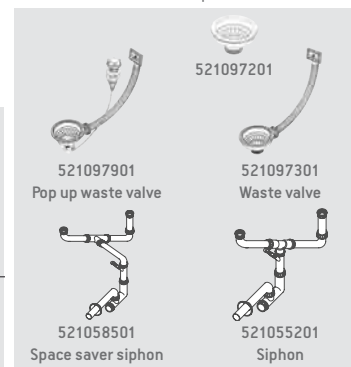

AMALTA PLUS 2B 1D LEFT HAND DRAINER

CODE	FINISH	TAP HOLES	WASTE	PACKAGING
107133001	SMOOTH	1	Ø92	SLEEVE



•Bowl Overflow

•Sink Dimensions:
1160 x 500mm

•Bowl Dimensions:
450 x 400 x 200mm
300 x 340 x 170mm



Installation drawings

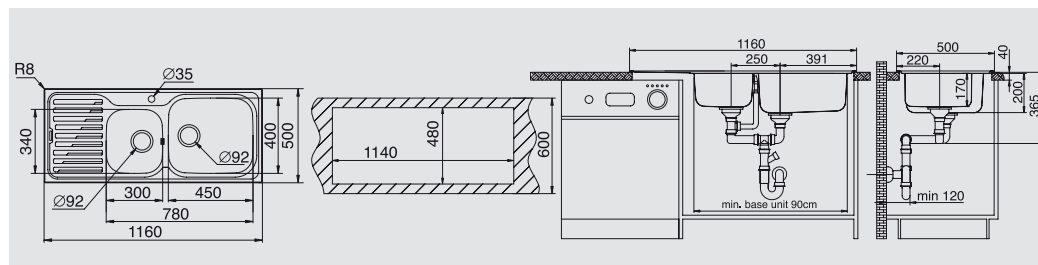

Optional accessories ▶



STEEL BASKET
525002701



BEECH CHOPPING BOARD
525005201

Proposed tap



ARMONIA

Suitable waste valves & siphons

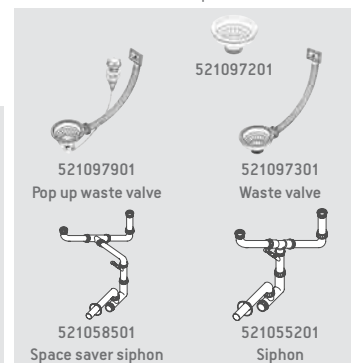

PYRAMIS



**SPACE SERIES
CLASSIC**

For those kitchens that require sinks with larger bowl sizes, this series offers unique versatility and functionality. Available with or without a drainer, Space models are designed to provide the utmost ergonomic benefits.

SPACE MINI 1 1/2B 1D

CODE	FINISH	TAP HOLES	WASTE	DRAINER	PACKAGING
108753901	SMOOTH	1+1	Ø92	REV	SLEEVE



- Bowl Overflow
- Sink Dimensions: 960 x 480mm
- Bowl Dimensions: 340 x 400 x 180mm and 165 x 290 x 120mm

Optional accessories ▶

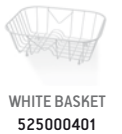
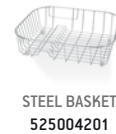

Proposed tap



Installation drawings

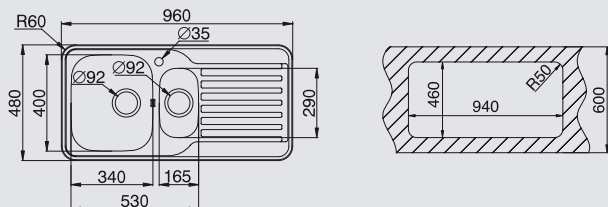

Suitable waste valves & siphons



SPACE PLUS 1B

CODE	FINISH	TAP HOLES	WASTE	PACKAGING
108717401	SMOOTH	1	Ø92	SLEEVE



•Bowl Overflow

•Sink Dimensions:
610 x 480mm

•Bowl Dimensions:
500 x 400 x 200mm

Optional accessories ▶



BEECH CHOPPING BOARD
525005201



Installation drawings

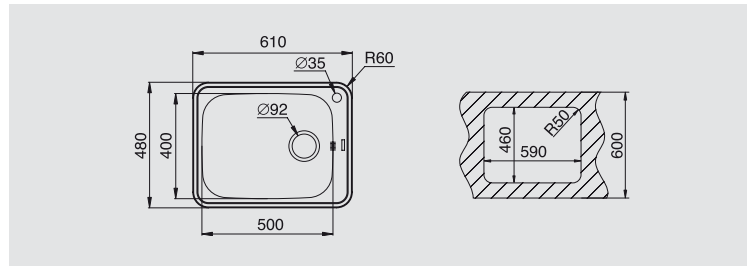

Proposed tap



ALTO

Suitable waste valves & siphons

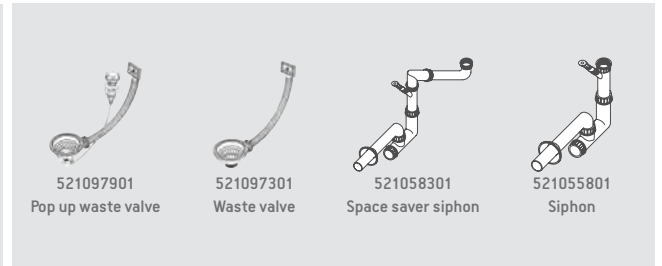

SPACE PLUS 1B 1D

CODE	FINISH	TAP HOLES	WASTE	DRAINER	PACKAGING
108755601	SMOOTH	1	Ø92	LEFT HAND	SLEEVE
108755501	SMOOTH	1	Ø92	RIGHT HAND	SLEEVE



•Bowl Overflow

•Sink Dimensions:
960 x 480mm

•Bowl Dimensions:
500 x 400 x 200mm

Optional accessories ▶



BEECH CHOPPING BOARD
525005201



Installation drawings

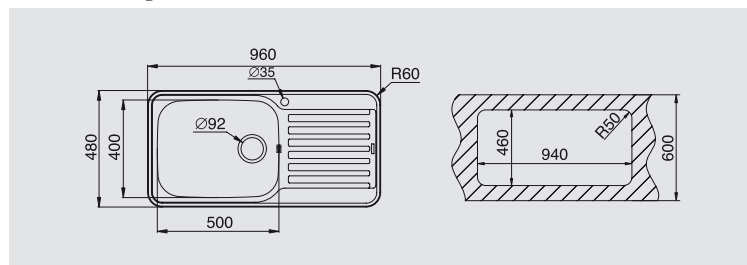

Proposed tap



VERSETO

Suitable waste valves & siphons

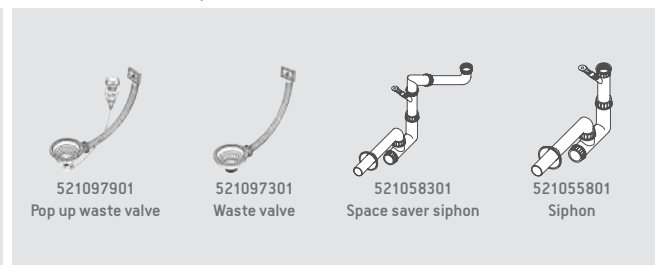

PYRAMIS



SR SERIES CLASSIC

An attractive rounded design that combines a circular bowl with a similarly styled drainer. Alternatively, a new design featuring two identical bowls has been developed for this attractive range.

SR MINI



• Bowl Overflow

• Sink Dimensions:
765 x 480mm

• Bowl Dimensions:
Ø385 x 150mm

CODE	FINISH	TAP HOLES	WASTE	DRAINER	PACKAGING
100167701	SMOOTH	1	Ø92	LEFT HAND	SLEEVE
100167601	SMOOTH	1	Ø92	RIGHT HAND	SLEEVE
100166801	SMOOTH	0	Ø92	REV	SLEEVE

Proposed tap



RONDELA

Installation drawings

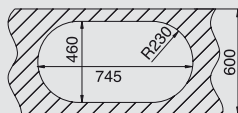
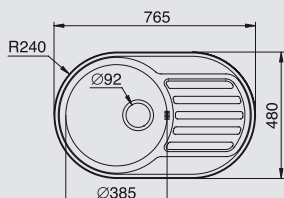

Suitable waste valves & siphons



521097901
Pop up waste valve



521097301
Waste valve

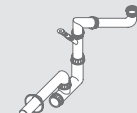

521058301
Space saver siphon

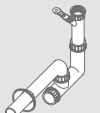

521055801
Siphon

SR 1

CODE	FINISH	TAP HOLES	WASTE	DRAINER	PACKAGING
108738001	SMOOTH	1+1	Ø92	REV	SLEEVE

Optional accessories ▶



STEEL BASKET
525002901



WHITE BASKET
525000501



WOOD CHOPPING BOARD
525003301



• Bowl Overflow

• Sink Dimensions:
900 x 480mm

• Bowl Dimensions:
Ø385 x 150mm

Proposed tap



ALTO

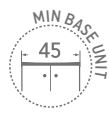

Installation drawings

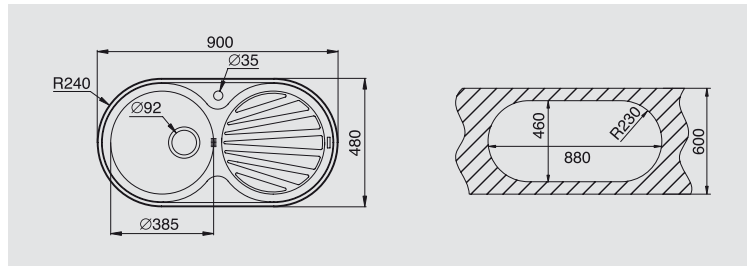

Suitable waste valves & siphons



521097901
Pop up waste valve



521097301
Waste valve

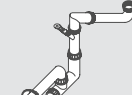

521058301
Space saver siphon



521055801
Siphon

PYRAMIS



IRIS SERIES CLASSIC

For those who require their sinks undermounted as part of the flush format of a stone, wooden or similar worksurfaces, the new stylish Iris series offers multiple bowl configurations to suit your own requirements.

PROPOSED IRIS BOWL COMBINATIONS

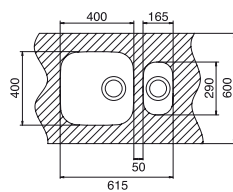

MIN. BASE UNIT: 70

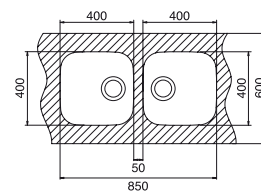

MIN. BASE UNIT: 90

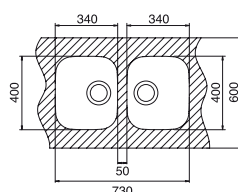

MIN. BASE UNIT: 80

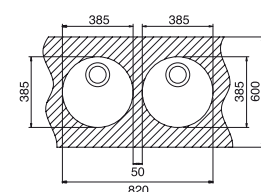

MIN. BASE UNIT: 90

IRIS (16,5X29)

CODE	FINISH	WASTE	PACKAGING
100001001	SMOOTH	Ø92	BOX OF 16 PIECES



•Outer Dimensions:
180 x 300mm

•Bowl Dimensions:
165 x 290 x 120mm



Optional accessories ▶



STEEL COLANDER
100060001



TRANSPARENT COLANDER
525000201

Installation drawing

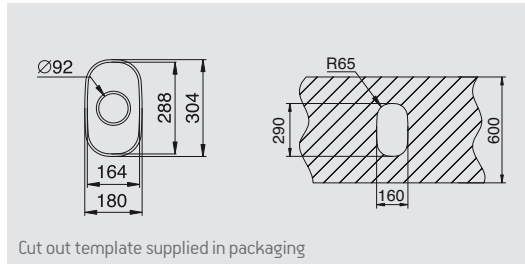

Cut out template supplied in packaging

Suitable waste valves



521101701
Waste valve



521090201
Pop up waste valve

IRIS (Ø38,5)

CODE	FINISH	WASTE	PACKAGING
100009401	SMOOTH	Ø92	BOX OF 10 PIECES



•Bowl Overflow

•Outer Dimensions:
Ø410mm

•Bowl Dimensions:
Ø385 x 150mm



Optional accessories ▶



STEEL BASKET
525002901



WHITE BASKET
525000501



BEECH CHOPPING BOARD
525003301

Installation drawing

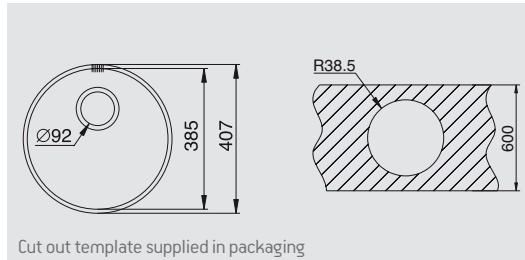

Cut out template supplied in packaging

Suitable waste valves



521101701
Waste valve



521090201
Pop up waste valve

IRIS (34X40)

CODE	FINISH	WASTE	PACKAGING
100009501	SMOOTH	Ø92	BOX OF 8 PIECES



•Bowl Overflow

•Outer Dimensions:
420 x 360mm

•Bowl Dimensions:
340 x 400 x 180mm



Optional accessories ▶



STEEL BASKET
525004201



BEECH CHOPPING BOARD
525004701

Installation drawing

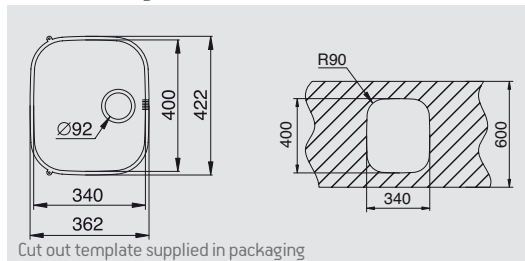

Cut out template supplied in packaging

Suitable waste valves



521101701
Waste valve



521090201
Pop up waste valve

PYRAMIS

IRIS (40X40)



- Bowl Overflow
- Outer Dimensions: 420 x 420mm
- Bowl Dimensions: 400 x 400 x 200mm



CODE	FINISH	WASTE	PACKAGING
100009301	SMOOTH	Ø92	BOX OF 8 PIECES

Optional accessories ▶



STEEL BASKET
525004001



BEECH CHOPPING BOARD
525005201

Installation drawing

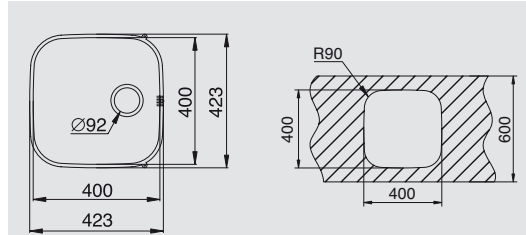

Cut out template supplied in packaging

Suitable waste valves



521101701
Waste valve



521090201
Pop up waste valve

IRIS (50X40)



- Bowl Overflow
- Outer Dimensions: 520 x 420mm
- Bowl Dimensions: 500 x 400 x 200mm



CODE	FINISH	WASTE	PACKAGING
100008401	SMOOTH	Ø92	BOX OF 4 PIECES

Optional accessories ▶



BEECH CHOPPING BOARD
525005201

Installation drawing

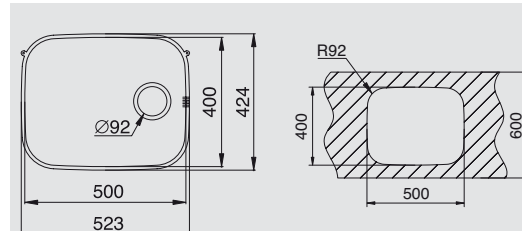

Cut out template supplied in packaging

Waste valves



521101701
Waste valve



521090201
Pop up waste valve



SPARTA SERIES
ESSENTIAL

Beautifully designed combinations of bowls and functional drainers at affordable prices. All SPARTA models are designed to meet and satisfy the demanding requirements of today's kitchens.

SPARTA (62X50) 1B 1D

CODE	FINISH	TAP HOLES	WASTE	PACKAGING
100132501	SMOOTH	1+1	Ø92	SLEEVE

Optional accessories ▶



STEEL BASKET
525002801



BEECH CHOPPING BOARD
525004801



- Bowl Overflow
- Sink Dimensions:
620 x 500mm
- Bowl Dimensions:
340 x 400 x 150mm



Installation drawings

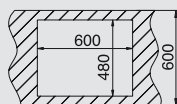
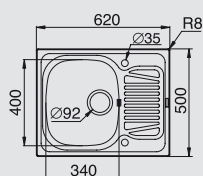

Suitable waste valve & siphon



521097301
Waste valve

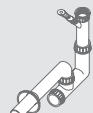

521055801
Siphon

PYRAMIS

SPARTA (62X50) 1 1/2B

CODE	FINISH	TAP HOLES	WASTE	PACKAGING
100135101	SMOOTH	1+1	Ø92	SLEEVE



Optional accessories ▶



TRANSPARENT COLANDER
525000801



STEEL BASKET
525002801



BEECH CHOPPING BOARD
525004801

•Bowl Overflow

•Sink Dimensions:
620 x 500mm

•Bowl Dimensions:
340 x 400 x 150mm
160 x 300 x 90mm



Installation drawings

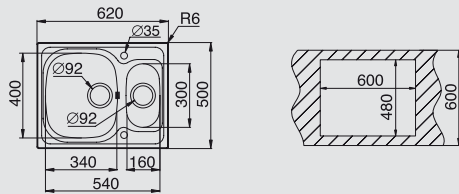

Suitable waste valve & siphon



521097301
Waste valve



521097201
Waste valve

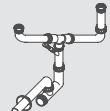

521055201
Siphon

SPARTA (86X50) 1B 1D

CODE	FINISH	TAP HOLES	WASTE	PACKAGING
100132901	SMOOTH	1+1	Ø92	SLEEVE



Optional accessories ▶



STEEL BASKET
525002801



BEECH CHOPPING BOARD
525004801

•Bowl Overflow

•Sink Dimensions:
860 x 500mm

•Bowl Dimensions:
340 x 400 x 150mm



Installation drawings

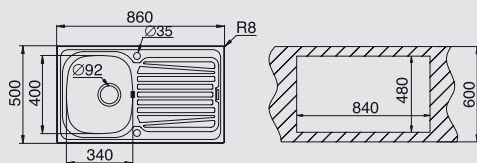

Suitable waste valve & siphon



521097301
Waste valve

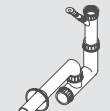

521055801
Siphon

SPARTA (100X50) 1 1/2B 1D

CODE	FINISH	TAP HOLES	WASTE	PACKAGING
100133201	SMOOTH	1+1	Ø92	SLEEVE

Optional accessories ▶



•Bowl Overflow

•Sink Dimensions:
1000 x 500mm

•Bowl Dimensions:
340 x 400 x 150mm
160 x 300 x 90mm



Installation drawings

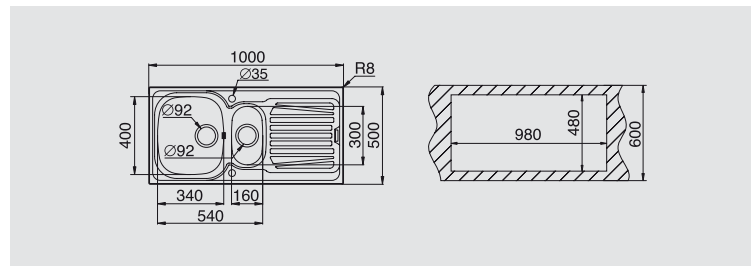

Suitable waste valve & siphon



SPARTA (116X50) 2B 1D

CODE	FINISH	TAP HOLES	WASTE	PACKAGING
100133101	SMOOTH	1+1	Ø92	SLEEVE

Optional accessories ▶



•Bowl Overflow

•Sink Dimensions:
1160 x 500mm

•Bowl Dimensions:
340 x 400 x 150mm
340 x 400 x 150mm

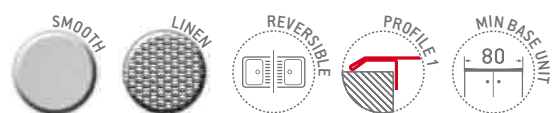

Installation drawings

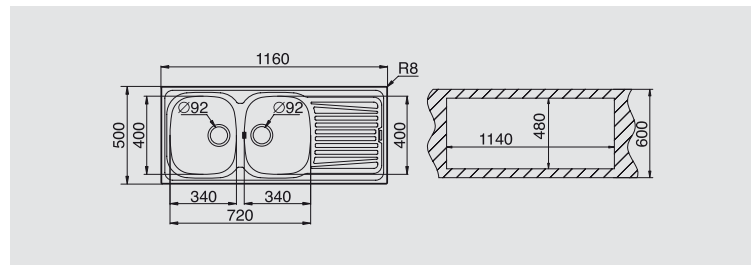

Suitable waste valve & siphon

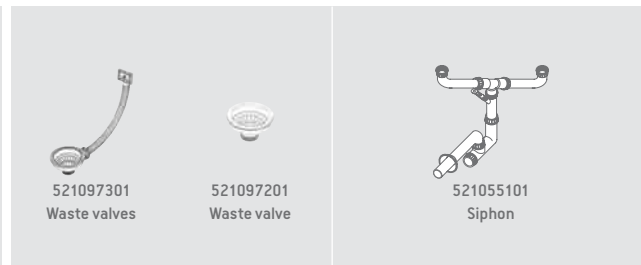



BASIC 33 SERIES
ESSENTIAL

These entry-level sinks offer functionality with neat design and offer excellent value for money.

E 33

CODE	FINISH	TAP HOLES	WASTE	PACKAGING
100139601	SMOOTH	0	Ø60	SLEEVE



- Bowl Overflow
- Sink Dimensions: 465 x 435mm
- Bowl Dimensions: 365 x 335 x 150mm



Installation drawings

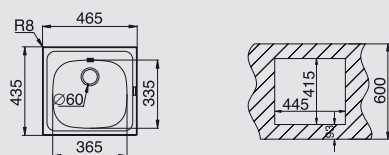

Suitable waste valve & siphon



CA 1

CODE	FINISH	TAP HOLES	WASTE	DRAINER	PACKAGING
100120901	SMOOTH	1+1	Ø60	REV	SLEEVE



Optional accessories ▶



WHITE BASKET
525000701

•Drainer Overflow

•Sink Dimensions:
860 x 435mm

•Bowl Dimensions:
365 x 335 x 150mm



Installation drawings

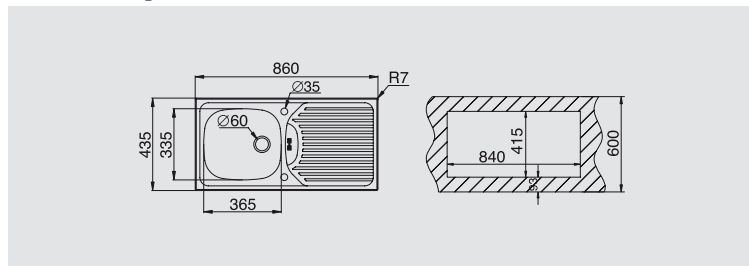

Suitable waste valve & siphon

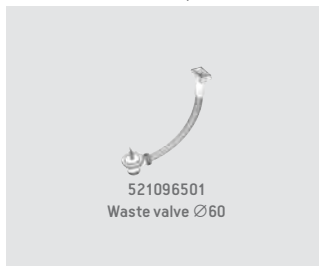

E 33/33

CODE	FINISH	TAP HOLES	WASTE	PACKAGING
100150801	SMOOTH	1	Ø60	SLEEVE



Optional accessories ▶



WHITE BASKET
525000701

•Bowl Overflow

•Sink Dimensions:
860 x 435mm

•Bowl Dimensions:
335 x 365 x 150mm
335 x 365 x 150mm



Installation drawings

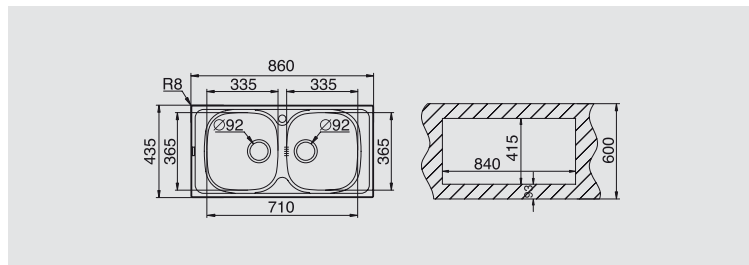

Suitable waste valves & siphon

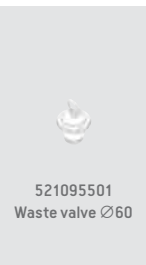

PYRAMIS



BRITISH INSET SERIES ESSENTIAL

Designed specifically for the UK market, these stylish inset sinks perfectly match standard dimensions of waste outlets and tap holes and are offered at affordable prices.

BS (50X51) 1B

CODE	FINISH	TAP HOLES	WASTE	PACKAGING
105031801	SMOOTH	2	Ø52	SLEEVE

Optional accessories ▶



BEECH CHOPPING
BOARD
525004701



•Bowl British Overflow

•Sink Dimensions:
500 x 510mm

•Bowl Dimensions:
400 x 340 x 150mm



Installation drawings

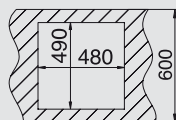
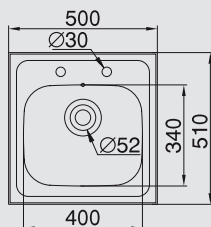

Suitable waste valve & siphon



521101301
Waste valve

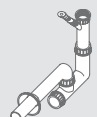

521055801
Siphon

BS (94X49) 1B 1D REV

CODE	FINISH	TAP HOLES	WASTE	DRAINER	PACKAGING
100165801	SMOOTH	1+1	Ø52	REV	SLEEVE



•Bowl British Overflow

•Sink Dimensions:
940 x 490mm

•Bowl Dimensions:
400 x 340 x 150mm



Optional accessories ▶



STEEL BASKET
525002801



BEECH CHOPPING
BOARD
525004801

Installation drawings

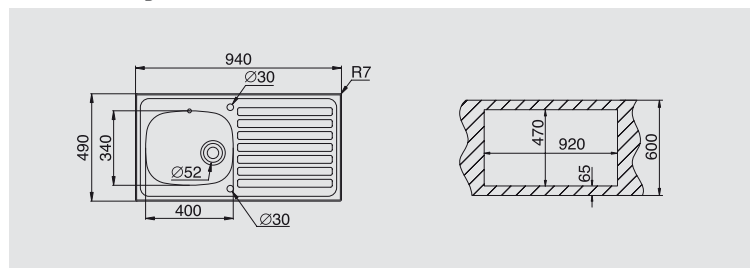

Suitable waste valve & siphon



BS (94X49) 1B 1D

CODE	FINISH	TAP HOLES	WASTE	DRAINER	PACKAGING
100127401	SMOOTH	1	Ø52	RIGHT HAND	SLEEVE
100127301	SMOOTH	2	Ø52	RIGHT HAND	SLEEVE
100127501	SMOOTH	1	Ø52	LEFT HAND	SLEEVE
100127201	SMOOTH	2	Ø52	LEFT HAND	SLEEVE



•Bowl British Overflow

•Sink Dimensions:
940 x 490mm

•Bowl Dimensions:
400 x 340 x 150mm



Optional accessories ▶



STEEL BASKET
525002801



BEECH CHOPPING
BOARD
525004801

Installation drawings

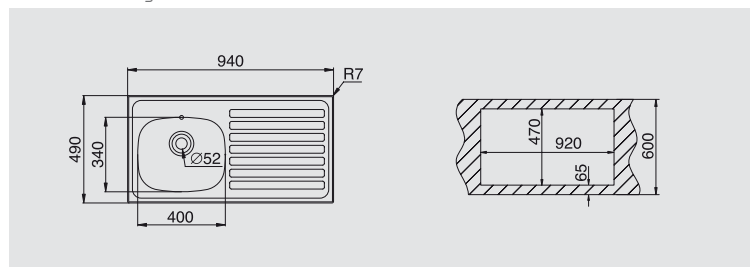

Suitable waste valve & siphon



PYRAMIS

BS (131X51) 1B 2D



• Bowl British Overflow

• Sink Dimensions:
1310 x 510mm

• Bowl Dimensions:
400 x 340 x 150mm



Installation drawings

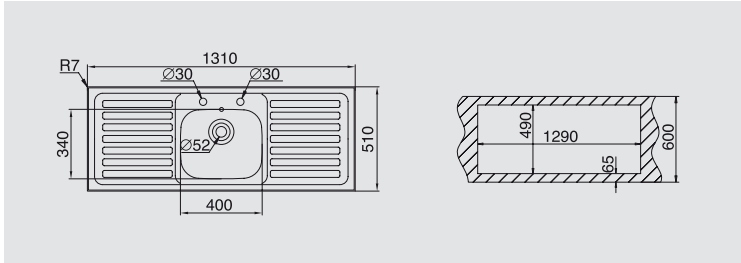

Suitable waste valve & siphon

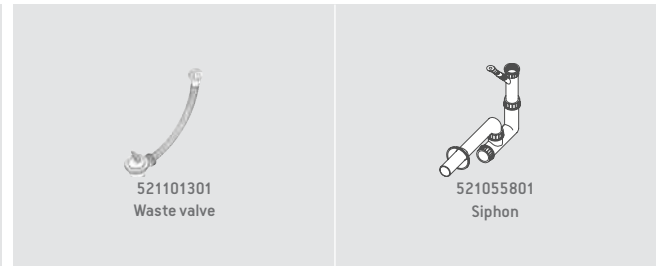

CODE	FINISH	TAP HOLES	WASTE	PACKAGING
105043001	SMOOTH	2	Ø52	SLEEVE

Optional accessories ▶



STEEL BASKET
525004201



WHITE BASKET
525000401



BEECH CHOPPING
BOARD
525004701

BS (131X51) 2B 1D



• Bowl British Overflow

• Sink Dimensions:
1310 x 510mm

• Bowl Dimensions:
400 x 340 x 150mm
400 x 340 x 150mm



Installation drawings

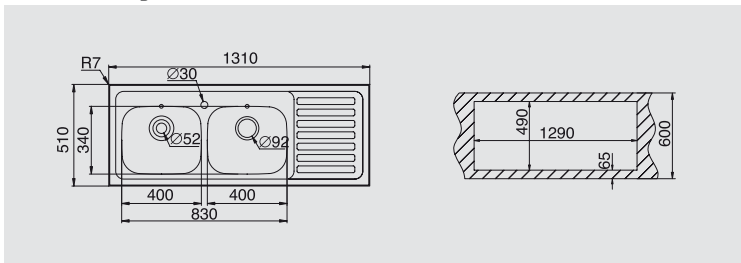

Suitable waste valve & siphon

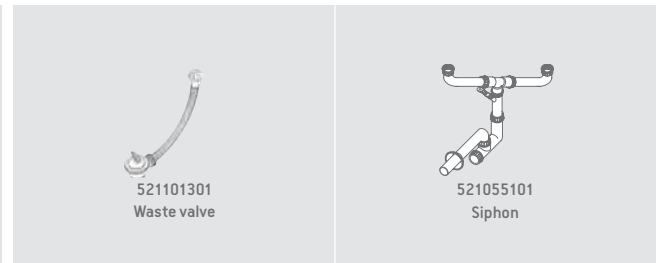

CODE	FINISH	TAP HOLES	WASTE	DRAINER	PACKAGING
105056801	SMOOTH	1	Ø52.92	RIGHT HAND	SLEEVE
105056701	SMOOTH	1	Ø52.92	LEFT HAND	SLEEVE

Optional accessories ▶



STEEL BASKET
525004201



WHITE BASKET
525000401



BEECH CHOPPING
BOARD
525004701



INSET BOWLS ESSENTIAL

We offer a wide range of inset bowls to perfectly complement any kitchen worktop design with a number of sizes and styles.

KIBA



- Bowl Overflow
- Sink Dimensions:
Ø485 x 160mm
- Bowl Dimensions:
Ø385 x 163mm

CODE	FINISH	TAP HOLES	WASTE	PACKAGING
100053501	SMOOTH	1	Ø60	BOX OF 10 PIECES
100053701	SMOOTH	1	Ø92	BOX OF 10 PIECES

Optional accessories ▶



STEEL BASKET
525002901



WHITE BASKET 525000501



BEECH CHOPPING BOARD
525003301

Installation drawings

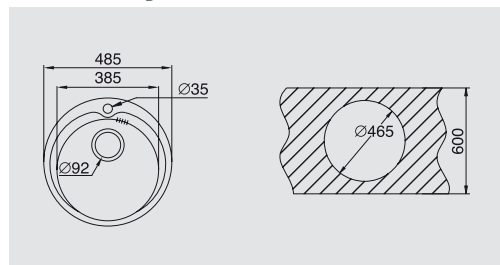

Suitable waste valves & siphons



521099801
Waste valve
Ø60



521097301
Waste valve
Ø92



521058301
Space saver siphon



521055801
Siphon



PYRAMIS

KIBA SQUARE



- Bowl Overflow
- Sink Dimensions:
465 x 405 mm
- Bowl Dimensions:
400 x 340 x 150 mm

Installation drawings

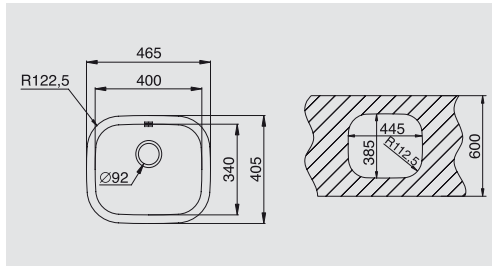

Suitable waste valve & siphons



Optional accessories ▶



BEECH CHOPPING
BOARD
525004701

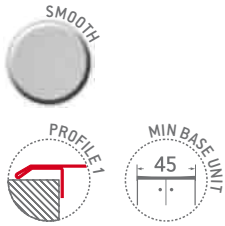

ATRIA



- Bowl Overflow
- Sink Dimensions:
575 x 505 mm
- Bowl Dimensions:
480 x 340 x 180 mm

Installation drawings

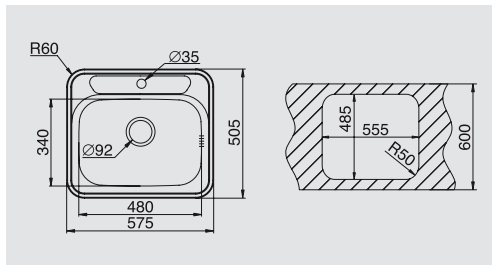

Suitable waste valves & siphons



CODE	FINISH	TAP HOLES	WASTE	PACKAGING
100081501	SMOOTH	1	Ø92	1 ITEM PER SLEEVE

CR



- Bowl Overflow
- Sink Dimensions:
Ø450 x 150 mm
- Bowl Dimensions:
Ø385 x 150 mm

Installation drawings

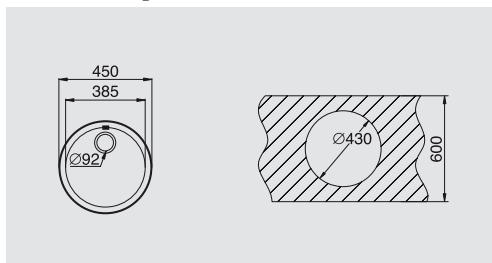

Suitable waste valve & siphons



Optional accessories ▶



STEEL
BASKET
525002901



BEECH CHOPPING
BOARD
525003301

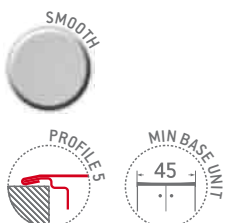

CODE	FINISH	WASTE	PACKAGING
100034701	SMOOTH	Ø92	BOX OF 10 PIECES

PYRAMIS

CT

CODE	FINISH	WASTE	PACKAGING
100040701	SMOOTH	Ø60	BOX OF 5 PIECES



•Sink Dimensions:
Ø450 x 30mm

•Bowl Dimensions:
Ø385 x 30mm

Installation drawings

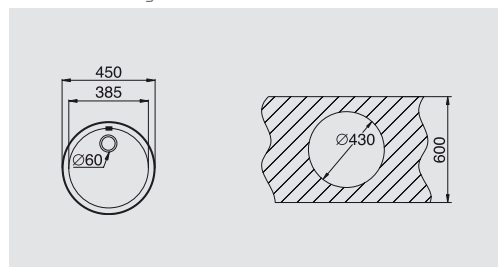

Suitable waste valve & siphon

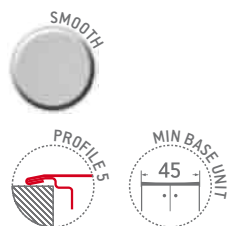
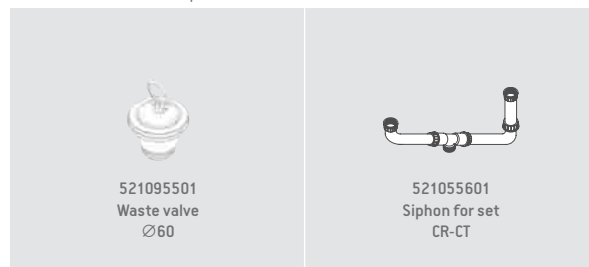

ROYAL

CODE	FINISH	WASTE	PACKAGING
100025301	SMOOTH	Ø60	BOX OF 5 PIECES



•Bowl British Overflow

•Sink Dimensions:
Ø450 x 160mm

•Bowl Dimensions:
Ø450 x 160mm

Installation drawings

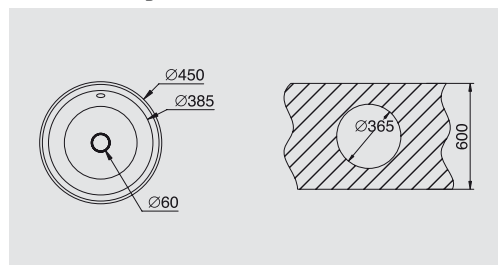

Suitable waste valve & siphons

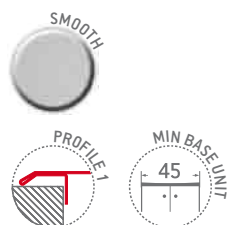
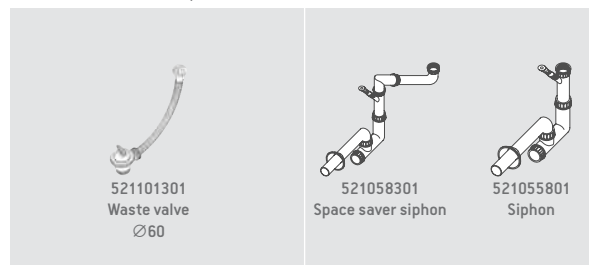

ROYAL MINI

CODE	FINISH	WASTE	PACKAGING
100025201	SMOOTH	Ø60	BOX OF 5 PIECES



•Bowl British Overflow

•Sink Dimensions:
Ø355 x 170mm

•Bowl Dimensions:
305 x 170mm

Installation drawings

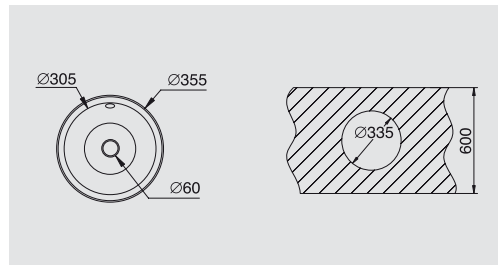

Suitable waste valve & siphons

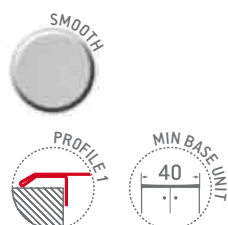
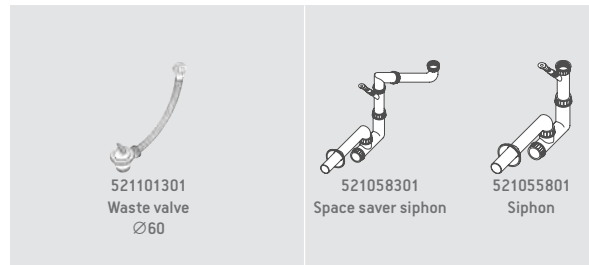

PYRAMIS



BRITISH ONSET TOP ESSENTIAL

A cleverly and specifically designed collection of onset sinks with medium sized bowls which are developed using UK outlet and tap specifications. Ideally created for the workplace, but can be used in the home.

BS (42X21) 1B 1D



CODE	FINISH	TAP HOLES	WASTE	DRAINER	BENDING TYPE	PACKAGING
102611001	SMOOTH	2	Ø52	RIGHT HAND	SQUARE EDGE	SLEEVE
102611101	SMOOTH	2	Ø52	LEFT HAND	SQUARE EDGE	SLEEVE

•Bowl British Overflow

•Sink Dimensions:
1067 x 543mm

•Bowl Dimensions:
400 x 400 x 150mm



Installation drawing

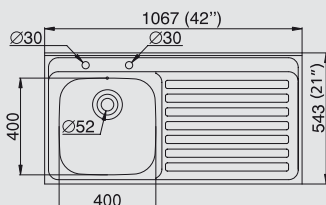

Suitable waste valve & siphon



521101301
Waste valve

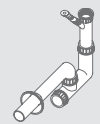

521055801
Siphon

BS (100X50) 1B 1D



- Bowl British Overflow
- Sink Dimensions: 1000 x 500mm
- Bowl Dimensions: 400 x 340 x 150mm



CODE	FINISH	TAP HOLES	WASTE	DRAINER	BENDING TYPE	PACKAGING
102611201	SMOOTH	2	Ø52	RIGHT HAND	SQUARE EDGE	SLEEVE
104405601	SMOOTH	2	Ø52	RIGHT HAND	ROLL FRONT	SLEEVE
102611301	SMOOTH	2	Ø52	LEFT HAND	SQUARE EDGE	SLEEVE
104405701	SMOOTH	2	Ø52	LEFT HAND	ROLL FRONT	SLEEVE

Installation drawing

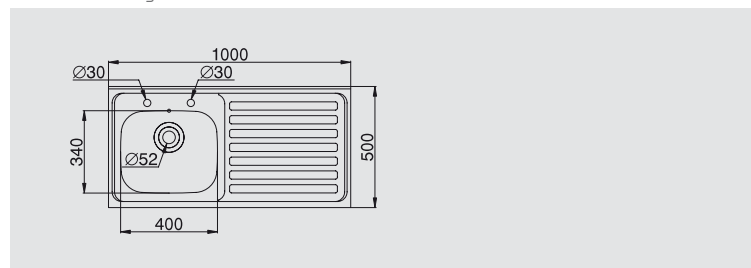

Suitable waste valve & siphon



BS (100X60) 1B 1D



- Bowl British Overflow
- Sink Dimensions: 1000 x 600mm
- Bowl Dimensions: 400 x 400 x 150mm



CODE	FINISH	TAP HOLES	WASTE	DRAINER	BENDING TYPE	PACKAGING
102610701	SMOOTH	2	Ø52	RIGHT HAND	SQUARE EDGE	SLEEVE
104405501	SMOOTH	2	Ø52	RIGHT HAND	ROLL FRONT	SLEEVE
102610601	SMOOTH	2	Ø52	LEFT HAND	SQUARE EDGE	SLEEVE
104405401	SMOOTH	2	Ø52	LEFT HAND	ROLL FRONT	SLEEVE

Installation drawing

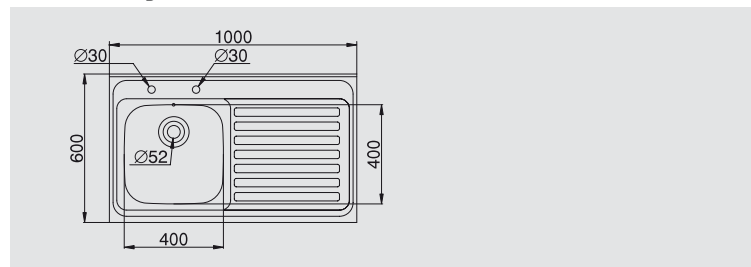

Suitable waste valve & siphon



PYRAMIS



MODULE WORKTOPS TOP ESSENTIAL

This is a new solution for the contemporary kitchen. This series will accommodate your hob appliances within the worktop, or just provide suitable stainless steel workspace with sink options. There are four separate styles to choose from, and all will provide the on-trend minimalist professional look.

MODULE BENCH



•Worktop Dimensions:
1200 x 600mm



CODE	FINISH	BENDING TYPE	PACKAGING
102408401	SMOOTH	SQUARE FRONT	SLEEVE

Installation drawing

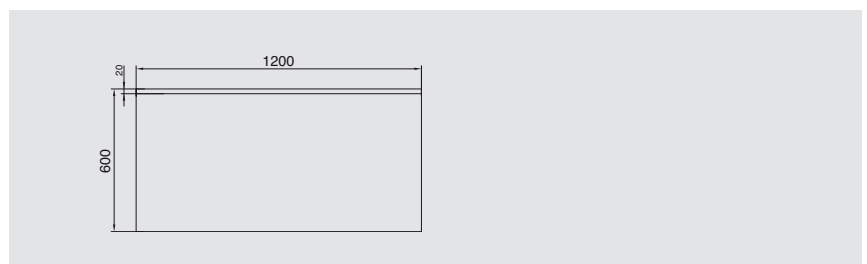

MODULE HOB BENCH



- Worktop Dimensions: 1200 x 600mm
- Cutout Dimensions: 560 x 485mm



CODE	FINISH	PACKAGING
102408301	SMOOTH	SLEEVE

Installation drawing

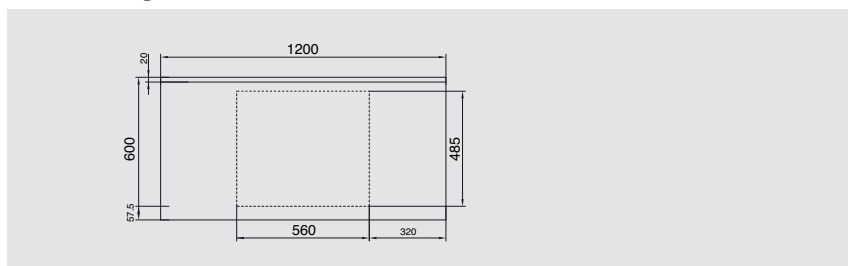

MODULE 1 1/2B L



- Bowl Overflow
- Sink Dimensions: 1200 x 600mm
- Bowl Dimensions: 400 x 400 x 200mm
165 x 290 x 120mm



CODE	FINISH	TAP HOLES	WASTE	BOWL POSITION	PACKAGING
102408601	SMOOTH	1	Ø92	LEFT HAND	1 ITEM PER CARTON BOX

Carton box includes: Waste valves & siphon.

Optional accessories ▶



STEEL BASKET
525004001



BEECH CHOPPING
BOARD
525005201



TRANSPARENT
COLANDER
525000201



STEEL COLANDER
100060001

Installation drawing

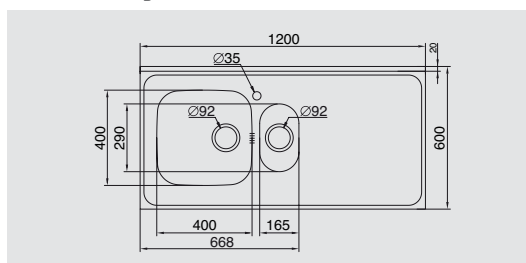

Included waste valves & siphon



MODULE 1 1/2B R



- Bowl Overflow
- Sink Dimensions: 1200 x 600mm
- Bowl Dimensions: 400 x 400 x 200mm
165 x 290 x 120mm



CODE	FINISH	TAP HOLES	WASTE	BOWL POSITION	PACKAGING
102408501	SMOOTH	1	Ø92	RIGHT HAND	1 ITEM PER CARTON BOX

Carton box includes: Waste valves & siphon.

Optional accessories ▶



STEEL BASKET
525004001



BEECH CHOPPING
BOARD
525005201



TRANSPARENT
COLANDER
525000201



STEEL COLANDER
100060001

Installation drawing

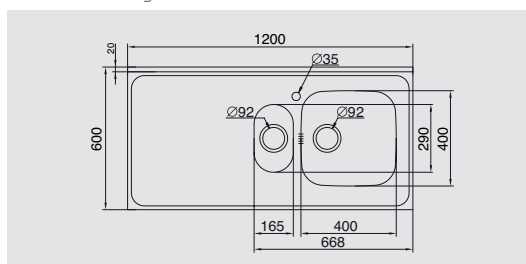

Included waste valves & siphon



SUITABLE FOR BOWL 300 X 340mm

CODE	DESCRIPTION
525002701	STEEL BASKET FOR BOWL 300X340

SUITABLE FOR BOWL 365 X 335mm

CODE	DESCRIPTION
525004101	STEEL BASKET FOR BOWL 365X335
525000701	WHITE BASKET FOR BOWL 365X335
525003001	BEECH CHOPPING BOARD FOR BOWL 365X335

SUITABLE FOR BOWL WELDED 340 X 400mm

CODE	DESCRIPTION
525004201	STEEL BASKET FOR BOWL 340X400
525000401	WHITE BASKET FOR BOWL 340X400
525004701	BEECH CHOPPING BOARD FOR BOWL 340X400

SUITABLE FOR BOWL MONOBLOCK 340 X 400mm

CODE	DESCRIPTION
525002801	STEEL BASKET FOR BOWL 340X400 MONOBLOCK
525004801	BEECH CHOPPING BOARD FOR BOWL 340X400 MONOBLOCK

SUITABLE FOR BOWL 400 X 400mm

CODE	DESCRIPTION
525004001	STEEL BASKET FOR BOWL 400X400
525005201	BEECH CHOPPING BOARD FOR BOWL 400X400/450/500

SUITABLE FOR BOWL Ø385mm

CODE	DESCRIPTION
525002901	STEEL BASKET FOR BOWL Ø385
525000501	WHITE BASKET FOR BOWL Ø385
525003301	BEECH CHOPPING BOARD FOR BOWL Ø385

SUITABLE FOR TITAN

CODE	DESCRIPTION
525005401	STEEL BASKET FOR TITAN
525005501	MAHOGANY CHOPPING BOARD FOR TITAN

GLASS CHOPPING BOARDS

CODE	DESCRIPTION
043000201	GLASS CHOPPING BOARD FOR TETRAGON, ASTRIS & CRYSTALON
043000601	BLACK GLASS CHOPPING BOARD FOR STUDIO

STEEL COLANDER



CODE	DESCRIPTION
043000501	STEEL COLANDER FOR TETRAGON, ASTRIS, CRYSTALON & STUDIO

SUITABLE FOR BOWL 135 X 260 X 100mm



CODE	DESCRIPTION
100055001	STEEL COLANDER FOR BOWL 135X260X100
525000101	TRANSPARENT COLANDER FOR BOWL 135X260X100

SUITABLE FOR BOWL 165 X 290 X 120mm



CODE	DESCRIPTION
100060001	STEEL COLANDER FOR BOWL 165X290X120
525000201	TRANSPARENT COLANDER FOR BOWL 165X290X120
525000801	TRANSPARENT COLANDER FOR SPARTA

SOAP DISPENSER



CODE	DESCRIPTION
028101001	SOAP DISPENSER

PYRAMIS STAINLESS STEEL CLEANING PRODUCTS



CODE	DESCRIPTION
043000301	CLEANING CREAM FOR STAINLESS STEEL SINKS
043000401	CLEANING CLOTH FOR STAINLESS STEEL SINKS

ELEGANT CATEGORY



SINK	521102101	521090201	521101701	521097201	521100601
STUDIO (86X50) 1B 1D RH&LH	•				
STUDIO (86X50) 2B	•			•	
STUDIO (100X50) 1 1/2B 1D RH&LH	•			•	
STUDIO (116X50) 2B 1D RH&LH	•			•	
CRYSTALON (86X53) 1B 1D RH&LH	•				
CRYSTALON (100X52) 1 1/2B 1D RH&LH	•		•		
CRYSTALON (116X52) 2B 1D RH&LH	•		•		
ASTRIS (17X40) 1B	•		•		
ASTRIS (34X40) 1B	•		•		
ASTRIS (40X40) 1B	•		•		
ASTRIS (45X40) 1B	•		•		
ASTRIS (50X40) 1B	•		•		
ASTRIS (74X40) 1B	•		•		
TETRAGON (17X40) 1B		•	•		
TETRAGON (34X40) 1B		•	•		
TETRAGON (40X40) 1B		•	•		
TETRAGON (45X40) 1B		•	•		
TETRAGON (50X40) 1B		•	•		
TETRAGON (55X40) 1D					•
TETRAGON (86,5X44) 2B		•	•		
TETRAGON (74,5X44) 2B		•	•		
TETRAGON (57,5X44) 2B RH&LH		•	•		

PREMIUM CATEGORY



SINK	521101701	521097301	521090201	521097901	521097201	521100301	521097501
DIONE (77X46) 2B	•		•		•		
DIONE (59X46) 1 1/2B RH&LH	•		•		•		
DIONE (65X40) 1 1/2B RH&LH	•		•		•		
DIONE (84X46) 2B RH&LH	•		•		•		
DIONE (85X46) 2B RH&LH	•		•		•		
ARIADNE (79X50) 1B 1D		•		•			
ARIADNE (86X50) 1B 1D		•		•			
ARIADNE (100X50) 1 1/2B 1D		•		•	•		
TITAN 1B		•		•			
AMALTIA (62X50) 1 1/2B		•		•	•		
AMALTIA (86X50) 1B 1D		•		•	•		
AMALTIA (86X50) 2B		•		•	•		
AMALTIA (100X50) 1 1/2B 1D		•		•	•		
AMALTIA (116X50) 2B 1D		•		•	•		
AMALTIA PLUS 1B 1D		•		•	•		
AMALTIA PLUS 2B 1D RH&LH		•		•	•		
DIMITRA RH&LH					•	•	•

CLASSIC CATEGORY

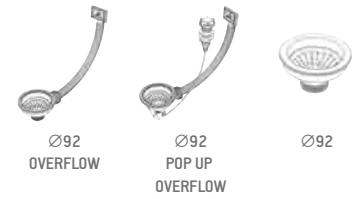

SINK	521097301	521097901	521097201
SPACE MINI 1 1/2B 1D	•	•	•
SPACE PLUS 1B	•	•	•
SPACE PLUS 1B 1D	•	•	•
SR MINI	•	•	•
SR1	•	•	•

ESSENTIAL CATEGORY



SINK	521101701	521090201	521095501	521099801	521096501	521097901	5211097201	521097301	521101301
IRIS (16,5X29)							•		
IRIS (38,5)	•	•							
IRIS (34X40)	•	•							
IRIS (40X40)	•	•							
IRIS (50X40)	•	•							
SPARTA (62X50) 1B 1D						•		•	
SPARTA (62X50) 1 1/2B						•	•	•	
SPARTA (86X50) 1B 1D						•	•	•	
SPARTA (100X50) 1 1/2B 1D						•	•	•	
SPARTA (116X50) 2B 1D						•	•	•	
E 33				•					
CA 1					•				
E 33/33			•	•					
BS (50X51) 1B									•
BS (94X49) 1B 1D REV									•
BS (94X49) 1B 1D RH&LH									•
BS (131X51) 1B 2D									•
BS (131X51) 2B 1D RH&LH									•
KIBA				•				•	
KIBA SQUARE								•	
ATRIA								•	
CR								•	
CT			•						
ROYAL									•
ROYAL MINI									•

TOP ESSENTIAL CATEGORY

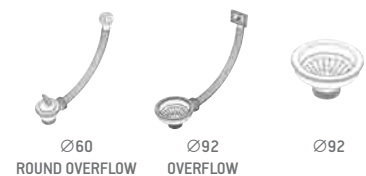

SINK	521101301	521097301	521097201
BS (42X21) 1B 1D RH&LH	•		
BS (100X50) 1B 1D RH&LH	•		
BS (100X60) 1B 1D RH&LH	•		
MODULE 1 1/2B RH&LH		•	•

PYRAMIS

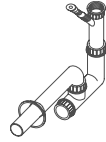

SIPHON FOR 1 BOWL
DISHWASHER CONNECTION

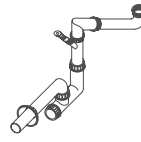

SPACE SAVER
SIPHON FOR 1 BOWL
DISHWASHER CONNECTION

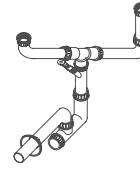

SIPHON FOR 1 1/2 BOWL
DISHWASHER CONNECTION

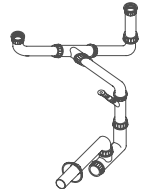

SPACE SAVER
SIPHON FOR 1 1/2 BOWL
DISHWASHER CONNECTION

SINK TYPES	521055801	521058301	521055201	521058501
1 BOWL SINK	•	•		
1 1/2 BOWL SINK			•	•

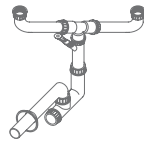

SIPHON
FOR 2 BOWLS
DISHWASHER CONNECTION

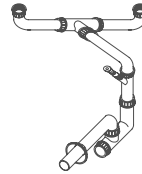

SPACE SAVER
SIPHON FOR 2 BOWLS
DISHWASHER CONNECTION

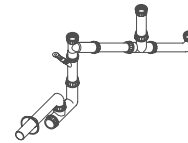

SIPHON
FOR 2 1/2 BOWLS
DISHWASHER CONNECTION

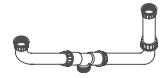

SIPHON
FOR BOWLS
WITH UNEQUAL DEPTH

SINK TYPES	521055101	521058401	521055301	521055601
2 BOWLS SINK	•	•		
2 1/2 BOWLS SINK			•	
ROUND BOWL SET CR CT				•

INSTALLATION KIT & SPARE PARTS OF STAINLESS STEEL SINKS

	CODE	DESCRIPTION
SEALING TAPES		
	522001301	SEALING TAPE 10 X 2mm VABER 4 ITEMS x52cm
	522001401	SEALING TAPE 10 X 2mm VABER 4 ITEMS x26cm
	522001501	SEALING TAPE 10 X 2mm VABER 2 ITEMS x26cm
	522010001	ROLL OF SEALING TAPE 6 x 4mm 2,05m
	522010301	ROLL OF SEALING TAPE 6 x 4mm 3,00m
	522010501	ROLL OF SEALING TAPE 6 x 4mm 3,40m
	522010801	ROLL OF SEALING TAPE 6 x 4mm 4,70m
	522010901	ROLL OF SEALING TAPE 8 x 4mm 2,50m
	522011201	ROLL OF SEALING TAPE 8 x 4mm 3,00m
	522011401	ROLL OF SEALING TAPE 8 x 4mm 3,40m
FIXING CLIPS FOR INSET SINKS		
	523000504	SET OF 4 CLIPS FOR INSET INSTALLATION
	523000506	SET OF 6 CLIPS FOR INSET INSTALLATION
	523030701	SET OF 4 FIXING CLIPS & ROLL OF SEALING TAPE 8 x 5mm 1,5m FOR CR & CT
FIXING CLIPS FOR UNDERMOUNT SINKS		
	523215601	SET OF 4 FIXING CLIPS
SPARE PARTS		
	043000101	TAP HOLE OPENER
	521055401	TAP HOLE COVER
	521058001	SIPHON ADAPTOR FOR BRITISH MARKET
	521101903	STEEL BASKET STRAINER FOR Ø92 WASTE VALVE
	521101904	STEEL BASKET STRAINER FOR Ø60 WASTE VALVE



PYRAGRANITE SINKS

PYRAMIS has built its excellent reputation for offering beautiful and functional stainless steel sinks. Responding to the growing demand for composite sinks, the company has developed its own collection of models, which provide a stylish alternative to its standard ranges. As with every product, every respect has been paid to the quality and colour standards that you would expect from a PYRAMIS product.



Satisfaction guaranteed

The unique advantage that characterizes the new PYRAGRANITE range is the revolutionary internationally patented molding method of production (GPS system). This method is an advanced self hardening composite material molding technology for kitchen sinks. The ultimate outcome of this molding technology is the even distribution of the components in the whole mass of the sink. The attributes of the sinks produced under this molding system are the increased resistance to impact, thermal shocks, and high temperatures, as well as an advanced look of the whole sink surface.

Materials

The new Pyragranite range is offered in two separate materials, GRANITE and METAL. Both feature 10 year guarantees.

Quality Systems and Certificates

The production of PYRAGRANITE TETRAGON, AVANT & HYDRIA series is certified by EN ISO 9001, ISO 14001, ITS (Intertek Testing Service Certification) for the American market, and EN 13310, a European norm for thermosetting composite sinks.

MORE THAN ONE TETRAGON!

Undermount Installation

Tetragon sinks can be installed under the counter, offering a subtle and modern way of placement.

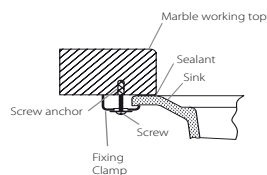
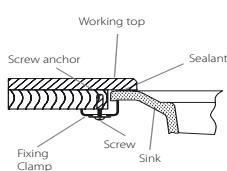

Flushmount Installation

One more way to enjoy a tetragon model is to place it on the same level with your counter. The sink and counter outline is milled to a 15° degree angle, to match perfectly.

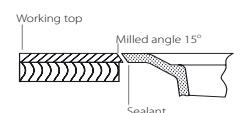
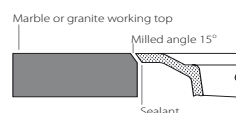

MATERIAL TYPES & COLOURS

▶ **Granite Type Colours**

Their chemical composition derives from natural granite granules, representing almost the 80% of the mass, with the rest to be colourless resin. The desired colouring of the finished product is obtained through an accurate choice of granite particles of a particular colour. It preserves the visual and textural effect of the natural stone.

GRANITE WHITE



GRANITE GREY



GRANITE BEIGE



GRANITE GRAPHITE



GRANITE SAND



GRANITE BLACK



▶ **Metal Type Colours**

The chemical composite is made of natural granite and acrylic resin. The unique advantage is that metal particles have been added among the elements mentioned, which confers an outstanding aesthetic finish. The composition of the mixtures is aimed at obtaining different metal looking effects and thus fit perfectly with stainless steel or other metallic appliances. Chromo metal particles give the chromium metallic color, Cast iron metal particles give the graphite metal colour, Aluminum particles give the aluminum metallic color and Titanium gives the titanium metal color.

METAL CHROME



METAL GRAPHITE



METAL ALUMINUM



METAL TITANIUM



ACCESSORIES



INOX BASKET
073022201



INOX BASKET
073022701



INOX BASKET
073022501



INOX BASKET
073022901



INOX BASKET
073023201



SLIDING WOOD CHOPPING BOARD
073022401



WHITE CHOPPING BOARD
073023301



WHITE CHOPPING BOARD
073022601



WOOD CHOPPING BOARD
073022301



POLYCARBONATE COLANDER
073023401



INOX COLANDER
073023501



COLANDER
073023001



COLANDER
073023101



SET (CHOPPING BOARD, COVER / COLANDER)
073022901





PYRAGRANITE TETRAGON

Evolutionary, and unusual, the Pyragranite sinks in this series are designed to complement all types of stainless steel appliances. The four metallic colours and geometric designs are developed to suit all types of state-of-the-art kitchen.

PYRAGRANITE TETRAGON 41X50 1B



•Sink Dimensions:
410 x 500mm

•Bowl Dimensions:
340 x 400 x 200mm



Installation drawings

Proposed tap



QUADRO

CODE	COLOUR
075700901	METAL CHROME
075700101	METAL GRAPHITE
075700801	METAL ALUMINUM
075701201	METAL TITANIUM

Packaging Carton box includes the installation kit, a regular waste valve & siphon.

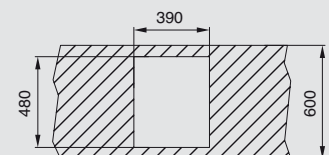
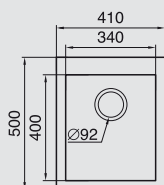

PYRAGRANITE TETRAGON

PYRAGRANITE TETRAGON 61X50 1B



•Sink Dimensions:
610 x 500mm

•Bowl Dimensions:
540 x 400 x 200mm

Proposed tap



SYMETRIA

Installation drawings

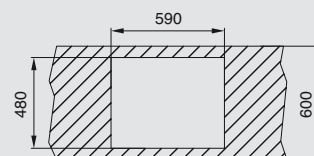
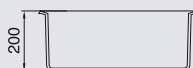
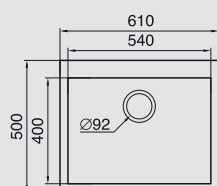

CODE	COLOUR
075800901	METAL CHROME
075800101	METAL GRAPHITE
075800801	METAL ALUMINUM
075801201	METAL TITANIUM

Packaging Carton box includes the installation kit, a regular waste valve & siphon.

PYRAGRANITE TETRAGON 79X50 1B



•Sink Dimensions:
790 x 500mm

•Bowl Dimensions:
720 x 400 x 200mm

Proposed tap



AVRA

Installation drawings

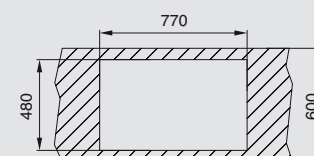
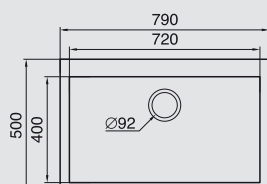

CODE	COLOUR
075900901	METAL CHROME
075900101	METAL GRAPHITE
075900801	METAL ALUMINUM
075901201	METAL TITANIUM

Packaging Carton box includes the installation kit, a regular waste valve & siphon.

PYRAMIS



PYRAGRANITE TETRAGON UNDERMOUNT

Offering subtle metallic tones, the four types of metal Pyragranite undermounted sinks will complement any sophisticated kitchen environment. In an open-plan kitchen they can add a real 'wow factor' if combined with a complementary worksurface and black or stainless steel kitchen appliances.

PYRAGRANITE TETRAGON 34X40 1B UND



CODE	COLOUR
076900901	METAL CHROME
076900101	METAL GRAPHITE
076900801	METAL ALUMINUM
076901201	METAL TITANIUM

Packaging Carton box includes the installation kit, a regular waste valve & siphon.

•Sink Dimensions:
380 x 440mm

•Bowl Dimensions:
340 x 400 x 200mm

Proposed tap



QUADRO



Installation drawings

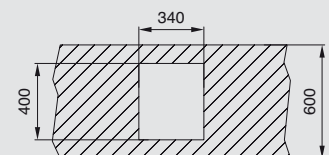
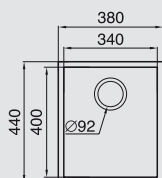

PYRAGRANITE TETRAGON 54X40 1B UND



•Sink Dimensions:
580 x 440mm

•Bowl Dimensions:
540 x 400 x 200mm

Proposed tap



SYMETRIA

Installation drawings

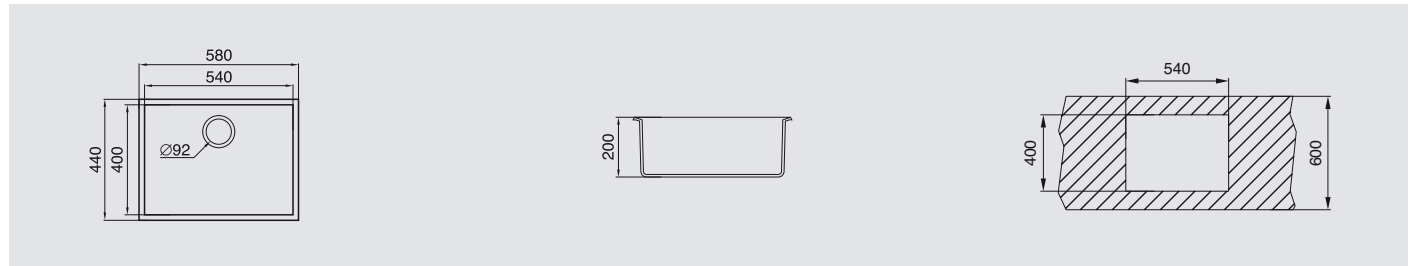

CODE	COLOUR
077100901	METAL CHROME
077100101	METAL GRAPHITE
077100801	METAL ALUMINUM
077101201	METAL TITANIUM

Packaging Carton box includes the installation kit, a regular waste valve & siphon.

PYRAGRANITE TETRAGON 72X40 1B UND



•Sink Dimensions:
760 x 440mm

•Bowl Dimensions:
720 x 400 x 200mm

Proposed tap



AVRA

Installation drawings

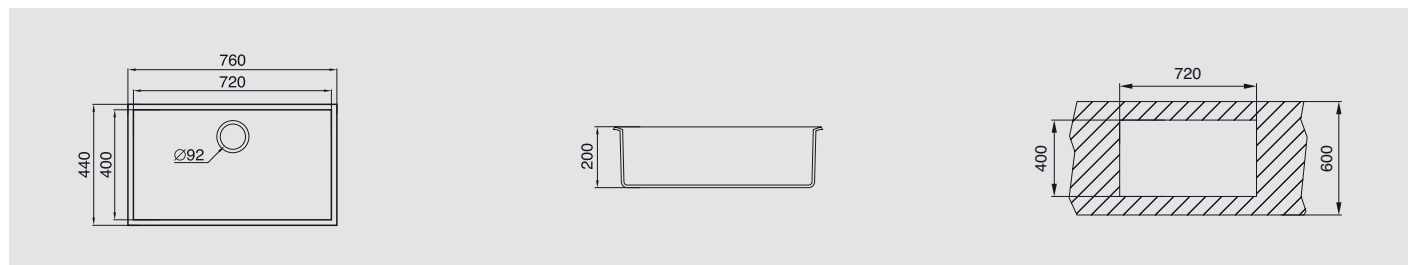

CODE	COLOUR
077000901	METAL CHROME
077000101	METAL GRAPHITE
077000801	METAL ALUMINUM
077001201	METAL TITANIUM

Packaging Carton box includes the installation kit, a regular waste valve & siphon.

PYRAMIS



PYRAGRANITE AVANT

Offering an entire line of precision granite sinks, the AVANT range is offered in a selection of colours and granite materials to accommodate any kitchen environment. Special emphasis has been made in the design to rectangular structures, minimalist style and extra bowl depths, ALL to suit current market trends. There are various options of bowl and drainer sizes.

PYRAGRANITE AVANT 86X50 1B 1D



•Sink Dimensions:
860 x 500mm

•Bowl Dimensions:
400 x 430 x 230mm



Installation drawings

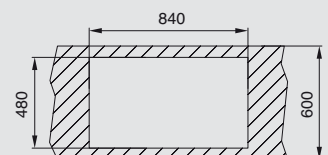
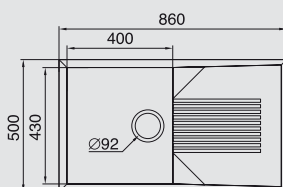

CODE	COLOUR	CODE	COLOUR
076100001	GRANITE WHITE	076101001	GRANITE BLACK
076100301	GRANITE BEIGE	076150901	METAL CHROME
076100701	GRANITE SAND	076150101	METAL GRAPHITE
076100601	GRANITE GREY	076150801	METAL ALUMINIUM
076100101	GRANITE GRAPHITE	076151201	METAL TITANIUM

Packaging Carton box includes the installation kit, an automatic waste valve & siphon.

Optional accessories ▶



SLIDING WOOD
CHOPPING BOARD
073022401



WHITE CHOPPING
BOARD
073023301



INOX
BASKET
073023201



POLYCARBONATE
COLANDER
073023401

Proposed tap



MAZORE

PYRAGRANITE AVANT 86X50 2B



•Sink Dimensions:
860 x 500mm

•Bowl Dimensions:
375 x 430 x 230mm



Installation drawings

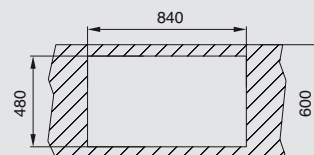
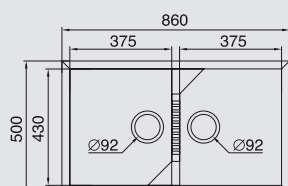

CODE	COLOUR	CODE	COLOUR
076200001	GRANITE WHITE	076201001	GRANITE BLACK
076200301	GRANITE BEIGE	076250901	METAL CHROME
076200701	GRANITE SAND	076250101	METAL GRAPHITE
076200601	GRANITE GREY	076250801	METAL ALUMINUM
076200101	GRANITE GRAPHITE	076251201	METAL TITANIUM

Packaging Carton box includes the installation kit, an automatic waste valve & siphon.

Optional accessories ▶



SLIDING WOOD
CHOPPING BOARD
073022401



WHITE CHOPPING
BOARD
073023301

Proposed tap



VERSETO



INOX
BASKET
073023201



POLYCARBONATE
COLANDER
073023401



INOX
COLANDER
073023501

PYRAGRANITE AVANT 100X50 1B 1D



•Sink Dimensions:
1000 x 500mm

•Bowl Dimensions:
480 x 430 x 230mm



Installation drawings

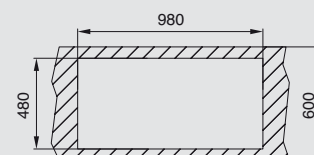
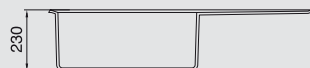
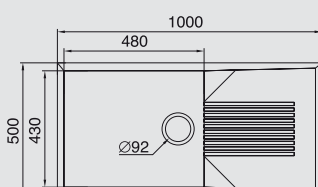

CODE	COLOUR	CODE	COLOUR
076300001	GRANITE WHITE	076301001	GRANITE BLACK
076300301	GRANITE BEIGE	076350901	METAL CHROME
076300701	GRANITE SAND	076350101	METAL GRAPHITE
076300601	GRANITE GREY	076350801	METAL ALUMINUM
076300101	GRANITE GRAPHITE	076351201	METAL TITANIUM

Packaging Carton box includes the installation kit, an automatic waste valve & siphon.

Optional accessories ▶



SLIDING WOOD
CHOPPING BOARD
073022401



WHITE CHOPPING
BOARD
073023301

Proposed tap



ADAGIO



INOX
BASKET
073023201



POLYCARBONATE
COLANDER
073023401

PYRAMIS

PYRAGRANITE AVANT 100X50 1 1/2B 1D



•Sink Dimensions:
1000 x 500mm

•Bowl Dimensions:
340 x 430 x 230mm
160 x 300 x 180mm



Installation drawings

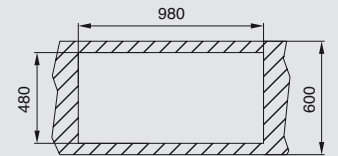
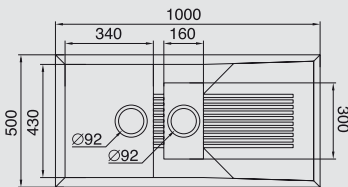

CODE	COLOUR	CODE	COLOUR
076500001	GRANITE WHITE	076501001	GRANITE BLACK
076500301	GRANITE BEIGE	076550901	METAL CHROME
076500701	GRANITE SAND	076550101	METAL GRAPHITE
076500601	GRANITE GREY	076550801	METAL ALUMINUM
076500101	GRANITE GRAPHITE	076551201	METAL TITANIUM

Packaging Carton box includes the installation kit, an automatic waste valve & siphon.

Optional accessories ▶

Proposed tap



ARIATA



INOX
BASKET
073023201



SLIDING WOOD
CHOPPING BOARD
073022401



WHITE CHOPPING
BOARD
073023301



POLYCARBONATE
COLANDER
073023401



INOX
COLANDER
073023501

PYRAGRANITE AVANT 116X50 2B 1D



•Sink Dimensions:
1160 x 500mm

•Bowl Dimensions:
380 x 430 x 230mm
300 x 430 x 190mm



Installation drawings

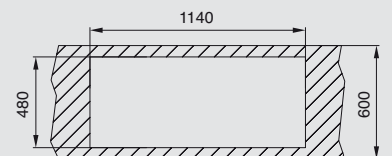
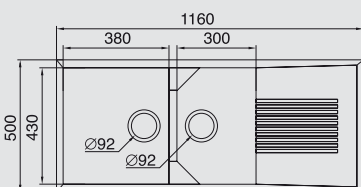

CODE	COLOUR	CODE	COLOUR
076600001	GRANITE WHITE	076601001	GRANITE BLACK
076600301	GRANITE BEIGE	076650901	METAL CHROME
076600701	GRANITE SAND	076650101	METAL GRAPHITE
076600601	GRANITE GREY	076650801	METAL ALUMINUM
076600101	GRANITE GRAPHITE	076651201	METAL TITANIUM

Packaging Carton box includes the installation kit, an automatic waste valve & siphon.

Optional accessories ▶

Proposed tap



ADAGIO



INOX
BASKET
073023201



SLIDING WOOD
CHOPPING BOARD
073022401



WHITE CHOPPING
BOARD
073023301



POLYCARBONATE
COLANDER
073023401



INOX
COLANDER
073023501

PYRAGRANITE PETRA



PYRAGRANITE PETRA

The word PETRA means 'stone' in Greek and this smooth and stylish stone sink series is created for kitchens with granite or composite worksurfaces to add a complementary or streamlined effect. Featuring a minimalist contemporary design, the smooth-to-the-touch drainer features an etched surface, which is attractive yet functional – allowing excess water to flow away with ease into the half bowl sink.

PYRAGRANITE PETRA 79X50 1B 1D



• Sink Dimensions:
790 x 500mm

• Bowl Dimensions:
325 x 410 x 210mm



CODE	COLOUR	CODE	COLOUR
077200001	GRANITE WHITE	077200601	GRANITE GREY
077200301	GRANITE BEIGE	077200101	GRANITE GRAPHITE
077200701	GRANITE SAND	077201001	GRANITE BLACK

Packaging Carton box includes the installation kit, a regular waste valve & siphon.

Optional accessories ▶



INOX BASKET
073023601

Installation drawings

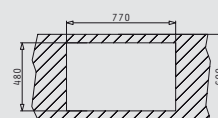
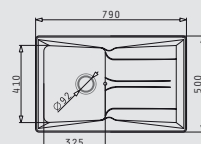

PYRAMIS

PYRAGRANITE PETRA 79X50 2B



•Sink Dimensions:
790 x 500mm

•Bowl Dimensions:
335 x 410 x 210mm
335 x 410 x 210mm



CODE	COLOUR	CODE	COLOUR
077300001	GRANITE WHITE	077300601	GRANITE GREY
077300301	GRANITE BEIGE	077300101	GRANITE GRAPHITE
077300701	GRANITE SAND	077301001	GRANITE BLACK

Packaging Carton box includes the installation kit, a regular waste valve & siphon.

[Optional accessories](#) ▶



INOX BASKET
073023601

Installation drawings

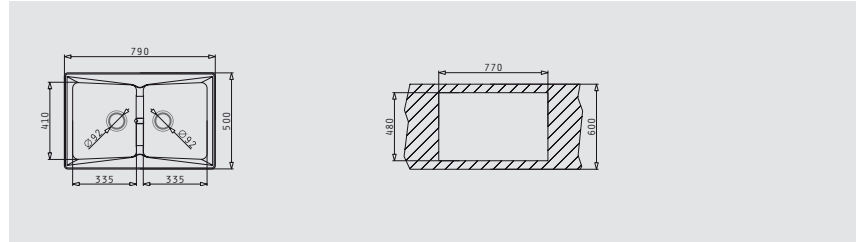

PYRAGRANITE PETRA 86X50 1B 1D



•Sink Dimensions:
860 x 500mm

•Bowl Dimensions:
325 x 410 x 210mm



CODE	COLOUR	CODE	COLOUR
077400001	GRANITE WHITE	077400601	GRANITE GREY
077400301	GRANITE BEIGE	077400101	GRANITE GRAPHITE
077400701	GRANITE SAND	077401001	GRANITE BLACK

Packaging Carton box includes the installation kit, a regular waste valve & siphon.

[Optional accessories](#) ▶



INOX BASKET
073023601

Installation drawings

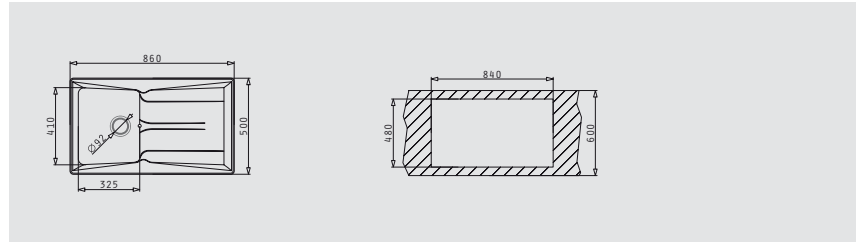

PYRAGRANITE PETRA 86X50 2B



•Sink Dimensions:
860 x 500mm

•Bowl Dimensions:
350 x 410 x 210mm
350 x 410 x 210mm



CODE	COLOUR	CODE	COLOUR
077500001	GRANITE WHITE	077500601	GRANITE GREY
077500301	GRANITE BEIGE	077500101	GRANITE GRAPHITE
077500701	GRANITE SAND	077501001	GRANITE BLACK

Packaging Carton box includes the installation kit, a regular waste valve & siphon.

[Optional accessories](#) ▶



INOX BASKET
073023601

Installation drawings

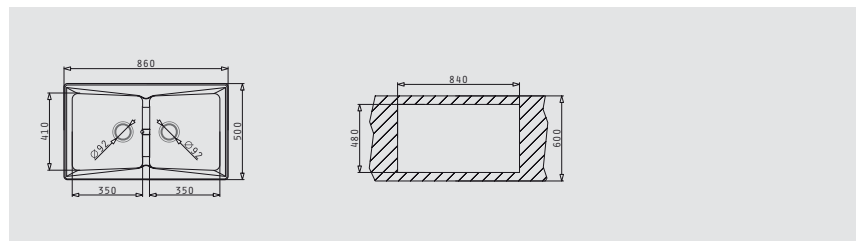

PYRAGRANITE PETRA

PYRAGRANITE PETRA 100X50 1 1/2B 1D



•Sink Dimensions:
1000 x 500mm

•Bowl Dimensions:
325 x 410 x 210mm
150 x 350 x 130mm



CODE	COLOUR	CODE	COLOUR
077600001	GRANITE WHITE	077600601	GRANITE GREY
077600301	GRANITE BEIGE	077600101	GRANITE GRAPHITE
077600701	GRANITE SAND	077601001	GRANITE BLACK

Packaging Carton box includes the installation kit, a regular waste valve & siphon.

[Optional accessories](#) ▶



INOX BASKET
073023601

Installation drawings

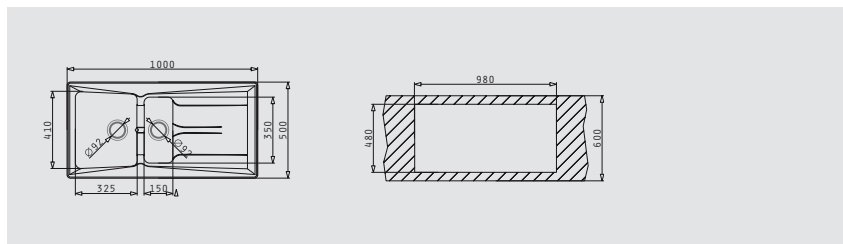

PYRAGRANITE PETRA 116X50 2B 1D



•Sink Dimensions:
1160 x 500mm

•Bowl Dimensions:
325 x 410 x 210mm
325 x 410 x 210mm



CODE	COLOUR	CODE	COLOUR
077800001	GRANITE WHITE	077800601	GRANITE GREY
077800301	GRANITE BEIGE	077800101	GRANITE GRAPHITE
077800701	GRANITE SAND	077801001	GRANITE BLACK

Packaging Carton box includes the installation kit, a regular waste valve & siphon.

[Optional accessories](#) ▶



INOX BASKET
073023601

Installation drawings

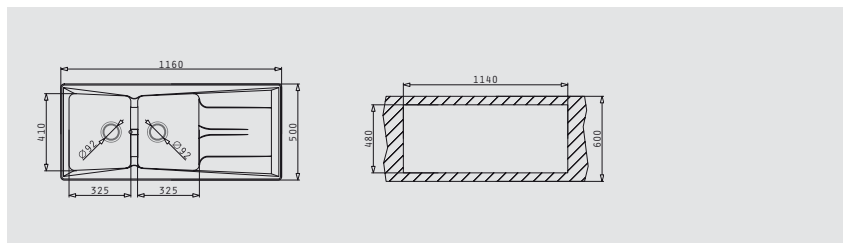

PYRAGRANITE PETRA CORNER 100X50 1 1/2B 1D



•Sink Dimensions:
1000 x 500mm

•Bowl Dimensions:
325 x 410 x 220mm
155 x 350 x 130mm



CODE	COLOUR	CODE	COLOUR
077700001	GRANITE WHITE	077700601	GRANITE GREY
077700301	GRANITE BEIGE	077700101	GRANITE GRAPHITE
077700701	GRANITE SAND	077701001	GRANITE BLACK

Packaging Carton box includes the installation kit, a regular waste valve & siphon.

[Optional accessories](#) ▶



INOX BASKET
073023601

Installation drawings

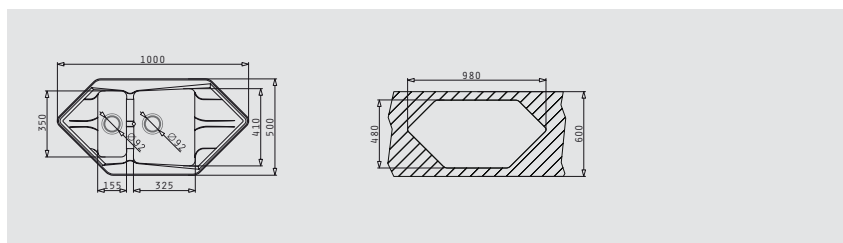



KITCHEN TAPS

Whether you are looking for traditional or cutting-edge design, PYRAMIS offers a stunning range of complementary taps to suit all expectations. A wide range of sink mixers are certified by the highest quality standards and also incorporate the innovative design and performance of our sinks collections. Our extensive and exclusive range will look good with any of our sink options and we have even chosen the perfect combinations throughout the brochure to make life even easier.



CHARACTERISTICS

PYRAMIS taps are manufactured according to the highest quality standards and their main advantages are their ergonomic, modern design and their durability. There is a complete range of products in satin and chrome that highlight and complement PYRAMIS stainless steel and PYRAGRANITE sinks.

▶ **Pure elegance**

The distinctive design is the hallmark for PYRAMIS taps. They are superbly formulated and crafted to offer years of dependable use and long-lasting beauty. The current additions of the AVRA and SYMETRIA models represent our commitment to an innovative approach.

▶ **Professional creation**

The use of professional tap models in home kitchens is a new trend, which promises exceptional style and functionality. The MAESTRO & MUSA models are the solution to the tasks of a challenging workload.

▶ **Hidden properties**

All taps are manufactured using state-of-the-art production technology. Each model has ceramic disc cartridges, which regulate both water flow and temperature. Moreover, the innovative pull out spray of RONDELA, PRESTO, ARIATA and ARMONIA models, simply eliminates unreachable areas.

▶ **ISO 9001**

PYRAMIS taps are produced according to ISO 9001:2000 requirements (clarifications may be obtained by consulting EQA).

The use of the specific mark indicates accreditation in respect of those activities covered by the accreditation certificate number 47.

Pressure Conditions

All models are suitable for water pressure starting from 1 bar to maximum of 5 bar. For pressure conditions different from 1-5 bar suitable accessories are available for adaptations upon request.

TYPES

CHROME



SATIN



BRONZE



PYRAMIS



KITCHEN TAPS ELEGANT & PREMIUM SERIES

Featuring timeless design and inspired aesthetics, these taps offer much more than just form and function. With nine separate models, including taps with a bending or pull-out spout, all combine practicality with elegance.

SYMETRIA



CODE	TYPE
096515901	CHROME

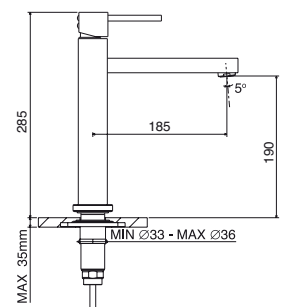

SINGLE LEVER MIXER WITH CERAMIC DISKS

QUADRO



CODE	TYPE
097000101	CHROME

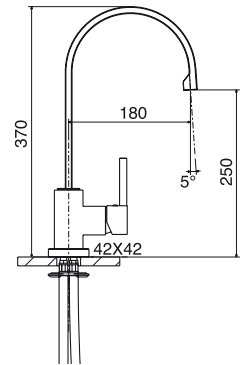

SINGLE LEVER MIXER WITH CERAMIC DISKS

MAESTRO



CODE	TYPE
096505801	CHROME

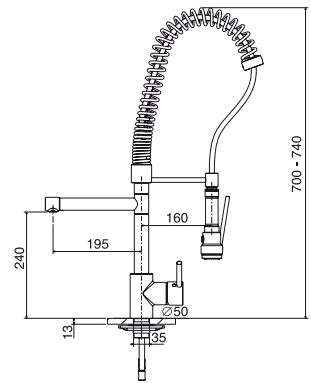

PRE-DISHWASHING SHOWER, ISLE MOUNTED TYPE

VERSETO



CODE	TYPE
098502401	CHROME

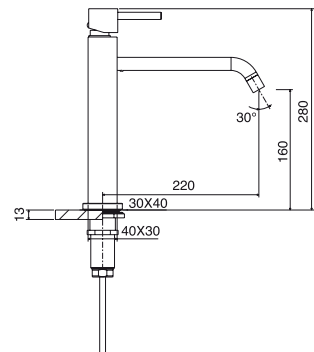

SINGLE LEVER MIXER WITH CERAMIC DISKS

ACCORDO



CODE	TYPE
096505701	CHROME

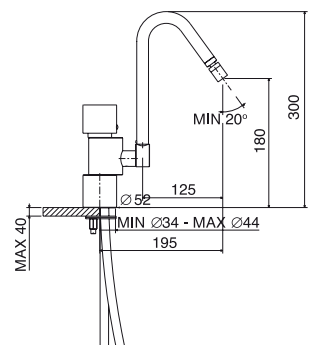

SINGLE LEVER MIXER WITH CERAMIC DISKS

PYRAMIS



KITCHEN TAPS CLASSIC & ESSENTIAL SERIES

These are the bestselling taps in our collection. Offering constant performance, these uncomplicated and ergonomic models service everyday demands in the kitchen.

ARMONIA



CODE	TYPE
096505401	CHROME

SINGLE LEVER MIXER WITH CERAMIC DISKS & SHOWER

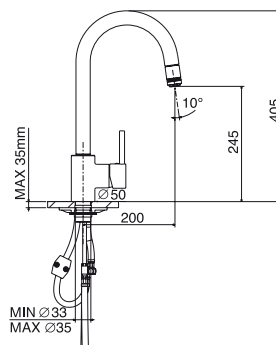

ADAGIO



CODE	TYPE
096505301	CHROME

SINGLE LEVER MIXER WITH CERAMIC DISKS

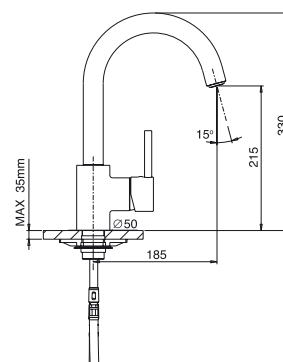

MAZORE



CODE	TYPE
096505501	CHROME

SINGLE LEVER MIXER WITH CERAMIC DISKS

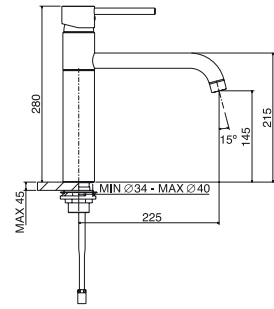

ACCENDO



CODE	TYPE
096505201	CHROME

SINGLE LEVER MIXER WITH CERAMIC DISKS

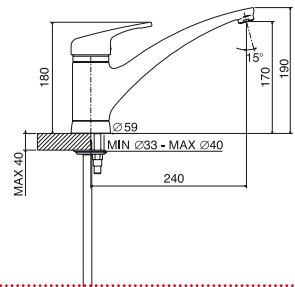

ARIA



CODE	TYPE
096404001	CHROME

SINGLE LEVER MIXER WITH CERAMIC DISKS

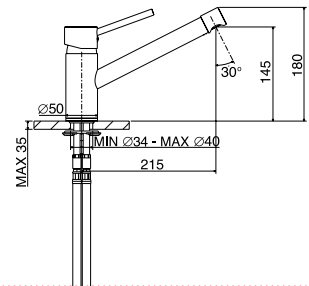

ARIATA



CODE	TYPE
096404101	CHROME

SINGLE LEVER MIXER WITH CERAMIC DISKS & SHOWER

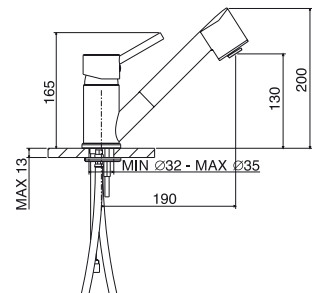

ALTO



CODE	TYPE
096505901	CHROME

SINGLE LEVER BENDING MIXER WITH CERAMIC DISKS

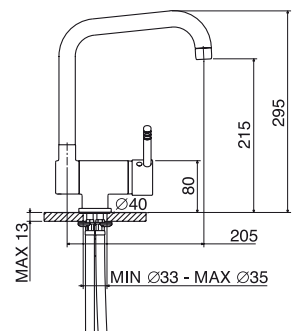

KITCHEN TAPS/CLASSIC

RIALTO



CODE	TYPE
096505601	CHROME

TWO LEVER MIXER WITH CERAMIC DISKS

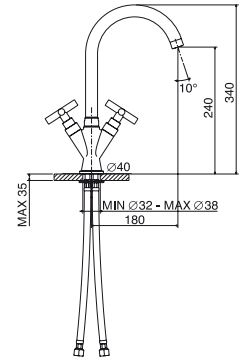

TEMPO



CODE	TYPE
096301001	CHROME

SINGLE LEVER MIXER WITH CERAMIC DISKS

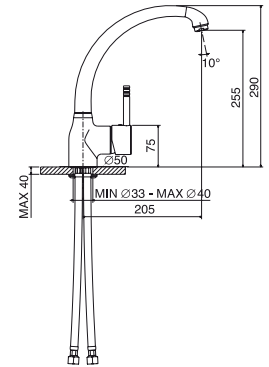

PRESTO



CODE	TYPE
096401001	CHROME

SINGLE LEVER MIXER WITH CERAMIC DISKS & SHOWER

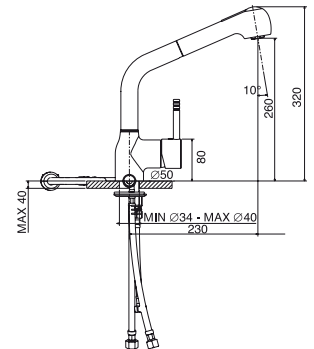

ALLEGRA



CODE	TYPE
096101001	CHROME

SINGLE LEVER MIXER WITH CERAMIC DISKS

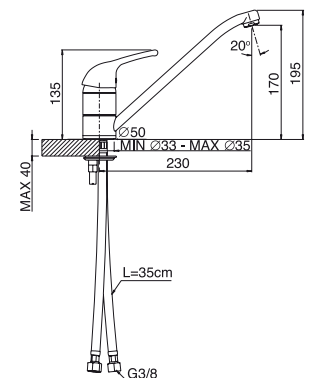

RONDELA



CODE	TYPE
096201001	CHROME

SINGLE LEVER MIXER WITH CERAMIC DISKS & SHOWER

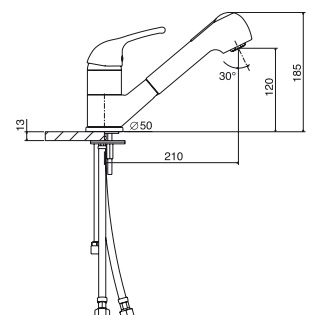

VIVA



CODE	TYPE
096505101	CHROME

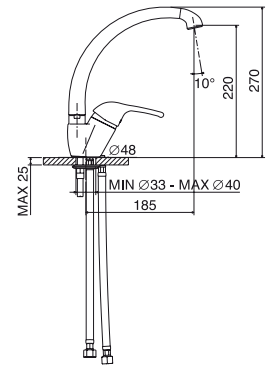

SINGLE LEVER MIXER WITH CERAMIC DISKS

SONATA



CODE	TYPE
096506001	CHROME

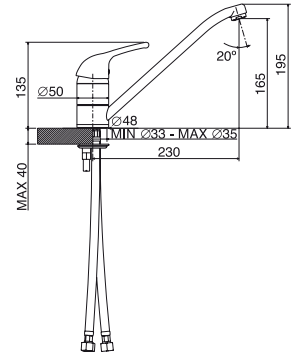

SINGLE LEVER MIXER WITH CERAMIC DISKS



PYRAMIS UK Ltd

Unit 5C Delta Drive,
Tewkesbury Business Centre
Tewkesbury, Gloucestershire GL20 8HB
Great Britain

Tel. 01684 298040

Fax. 01684 293114

sales@pyramisuk.com
www.pyramisgroup.co.uk